



DirectConnect[®]



DirectConnect[®]
Dealer Catalog

Volume 11

\$7.95

CONTENTS

Amps/Splitters56

Baluns/Extenders*Matrix/ Video Switches/Converters3-9

Audio.....	8
Component	5, 7, 8
Composite.....	6, 7, 8
HDMI	3, 4, 5, 6, 8
IP/POE	9
RS232	6, 9
S-VIDEO.....	5
SVTA/VGA	4, 6
USB	9

CCTV18-21

Bullet Cameras	19
Dome Cameras	18
DVR/Monitors	20
Lens Calculator	21
Microphones	20
Power Supplies	20

Connectors/Adaptors.....47-51

1/4"	50
2.1mm	51
3.5mm	48, 50, 51
5WBJ/BP.....	47
Banana	47
BNC	48, 49, 50, 51
F	47, 48, 49, 50, 51
Fiber Optical	51
HDMI.....	51
Modular Plugs	25, 51
RCA	47, 48, 49, 50
Spade Lugs.....	47
VGA.....	51

Electrical52

AC Power Cords.....	52
Power Supplies	52
Work Boxes	52

Hardware.....54-55

Antenna FM.....	55
Bridal/Drive Rings	55
Conduit	54
Electrical Tape	54
Ground Clamps	55

HDMI™

HDMI, the HDMI logo and High Definition Multi-Media Interface are trademarks or registered trademarks of HDMI Licensing, LLC in the United States and other countries

Hook & Latch	54
Screws	55
Shoe Covers	55
Terminals/Wire Nuts	54

Interconnects26-30

3.5mm	29, 30
Audio	26, 27, 29
AV Dubbing	26, 27, 30
Category Patch Cables.....	27
Component	26, 27
Composite.....	26, 27
HDMI.....	28
Optical Toslink	26
RGB	27
Subwoofer	26
SVGA/XVGA	27, 29, 30
S-VIDEO	26, 29, 30
Y-Cables	27, 28, 29

IR.....45-46

Connecting Blocks.....	45, 46
Emitters	45, 46
Kits	45
Power Supply.....	45, 46
Receivers	45, 46
Volume Controls	36

Mounts/Equipment Racks12-15

Equipment Racks.....	15
Patch Panel/Hinged Wall Mounts	14
TV/Projector	12, 14

Plates.....37-44

6.2 Home Theater Plate.....	38
Audio Configurable.....	39
Blanks.....	43
Bulk Wire NOSE.....	37
Cresnet®	38
Decorator Trim.....	40
HDMI	38, 43

Keystone

EZ Jacks	42, 43
Inserts	38, 39, 41, 42, 43
Plates	38, 39, 40, 41, 43
Oversize	41
Phone/TV	43, 44
Specialty.....	38, 39, 40, 42
SVGA.....	38
USB	42

Projector Screens16-17

Fixed	16
Manual	17
Motorized	16, 17
Motorized Tab Tension	16

Security Contacts53

Speakers10-11

Inwall/Inceiling.....	10
Outdoor/Rock	11

Structured Panels22-23

Accessories	23
Modules	22, 23
Panels.....	22
WiFi Antenna Mounts.....	23

Telecom24-25

Line Cords.....	25
Modular Plugs	25, 51
Patch Panels	24
Patch Panels Hinged Wall Mounts	14, 24
Punch Blocks.....	24
Telecom Accessories	25
Tools	24

Tools57-58

Volume Controls36

IR	36
Slide	36
Standard Rotary	36
Table Top.....	36
Weather Proof Outdoor.....	36

Wire and Bulk Cable31-35

Category Cable

5E & 6 Data	32, 34, 35
-------------------	------------

Coax

Ariel	33
Burial	33
Dual Audio.....	35
Plenum	33
RG59	32, 33
RG6	33
RG6Q	32, 33
Siamese	33, 35

Control/Composite Bundled

CCTV Camera	33
Cresnet®	35
IR	35
Keypad	32
Lighting	35
RGB	32
Shielded	35
Structured	32

Security

Contact Cable	32
Fire Cable	32

Speaker

Burial	31
PVC Standard & HD	31
Plenum	31
Shielded	31

VIDEO MATRIX AND SWITCHERS

5X1 HDMI™ Switcher

- Switch between 5 HDMI™ inputs
- Supports 1.3b up to full 1080p and up to 1920 x 1080 computer resolution with up to 36-bit deep color
- Video amplifier bandwidth: 250MHz with speed up to 2.25Gbps per channel
- Front HDMI™ input jack
- Touch control and IR wireless remote
- HDCP pass-through
- Sold as each



Model HS51M/SKU# .17933

3X1 HDMI™ Switch

- Switch up to 3 HDMI™ inputs into 1 HDMI™ output
- 1.3b resolution up to full 1080p
- Optional extender may be needed for runs greater than 16.4 feet (5 meters)
- Sold as each



Model HS31/SKU# .15096

2X1 HDMI™ Switcher

- HDMI™ 2 in 1 out distribution switch
- Switch between 2 HDMI™ inputs
- PC: VGA, SVGA, XGA, SXGA, UXGA, WUXGA (1920 X 1080)
- HDTV: 480i, 576i, 480p, 576p, 720p, 1080i, 1080p @ 60HZ
- Supports HDCP
- Sold as each



Model HS21/SKU# .16252

4X4 HDMI™ Matrix

- Switch up to 4 HDMI™ inputs and 4 HDMI™ outputs
- Supports 1.3b up to full 1080p and up to 1920 x 1080 computer resolution with up to 36-bit deep color
- Video amplifier bandwidth: 225 MHz with speed up to 6.75Gbps
- True RS-232 control port and IR port
- Discrete code IR wireless remote
- Sold as each



Model HM44/SKU# .17946

3X1 HDMI™ Switcher

- Switch between 3 HDMI™ inputs
- 1.3b HDTV resolution up to full 1080p, 2k, 1440P graphics, and up to 1920 x 1200 computer resolution with up to 36-bit deep color
- Video amplifier bandwidth: 250 MHz with speed up to 7.5Gbps
- Supports 5-meter HDMI™ cable on both ends of the switcher; discrete code IR wireless remote
- Sold as each



Model HS31M/SKU# .17936

1X4 HDMI™ Amp

- 1 in 4 out HDMI™ distribution amp
- 1.3b resolution up to full 1080P
- Optional extender may be needed for runs greater than 32.8 ft (10 meters)
- Power supply included
- Sold as each



Model 41HDMIAMP/SKU# .16249

4X2 HDMI™ Matrix

- Switch up to 4 HDMI™ inputs and 2 HDMI™ outputs
- 1.3b HDTV resolution up to full 1080p, 2k, 1440P graphics, and up to 1920 x 1200 computer resolution with up to 36-bit deep color
- Video amplifier bandwidth: 2.25 MHz with speed up to .75Gbps
- True RS-232 control port and IR port
- Discrete code IR wireless remote
- Sold as each



Model HM42/SKU# .17947

2X4 HDMI™ Matrix

- Switch up to 2 HDMI™ inputs and 4 HDMI™ outputs
- 1.3b HDTV resolution up to full 1080p, 2k, 1440P graphics, and up to 1920 x 1200 computer resolution with up to 36-bit deep color
- Video amplifier bandwidth: 225 MHz with speed up to 6.75Gbps
- True RS-232 control port and IR port
- Discrete code IR wireless remote
- Sold as each



Model HM24/SKU# .17949

1X2 HDMI™ Amp

- HDMI™ 1 in 2 out distribution amplifier HDCP 1080P – Same video to 2 sources
- Connects up to 2 HDMI™ displays at the same time to one video source
- PC: VGA, SVGA, XGA, SXGA, UXGA
- HDTV: 480i, 576i, 480p, 576p, 720p, 1080i, 1080p @ 60HZ
- HDMI™ compliant at all channels
- Supports HDCP
- Sold as each



Model HS12/SKU# .16248

4X1 HDMI™ Switcher

- Switch between 4 HDMI™ inputs
- Supports 1.3b up to full 1080p and up to 1920 x 1080 computer resolution with up to 36-bit deep color
- Video amplifier bandwidth: 250 MHz with speed up to 2.25Gbps per channel
- Front HDMI™ input jack
- Touch control and IR wireless remote
- HDCP pass-through
- Sold as each



Model HS41/SKU# .16253

2X2 HDMI™ Matrix

- Switch up to 2 HDMI™ inputs and 2 HDMI™ outputs
- Supports 1.3b HDTV resolution up to full 1080p, 2k, 1440P graphics, and up to 1920 x 1200 computer resolution with up to 36-bit deep color
- Video amplifier bandwidth: 225 MHz with speed up to 6.75Gbps
- True RS-232 control port and IR port
- Discrete code IR wireless remote
- Sold as each



Model HM22/SKU# .17948

Matrix Counter Display

- Table-top POS display
- Includes SKU# .17933, .17946, .17947



DISPLAYMATRIX/SKU# .18950

HDMI™ EXTENDERS AND BALUNS

HDMI™ over dual CAT5 Extender

- Transmit high-quality digital video and audio over CAT5
- Transmission range up to 164 feet/50 meters at hi-resolution 1080p
- Built-in equalization and signal boost function
- Set includes one transmitter, one receiver, and two 5V power adaptors
- HDCP compliant
- Optional receiver C5HRX (SKU# .15698)
- Sold in pairs



Model C5DH/SKU# .15697

HDMI™ over single CAT5 Extender

- Transmission range up to 164 feet/50 meters at 1080p
- Built-in equalization and signal boost function
- Set includes one transmitter, one receiver, and two 5V power adaptors
- Video bandwidth: 1.65Gbps
- Supports HDMI™ and DVI with the proper DVI adaptor
- HDCP compliant
- Sold in pairs



Model C5H/SKU# .16245

HDMI™ CAT5 Balun

- Wall plate HDMI™ CAT5/5e/6 cable balun; extends HDMI™ signal over two CAT5
- High quality digital video and audio over CAT5
- Transmission range up to 328 feet/100M at 1080p resolution
- HDCP compliant
- White
- Sold in pairs



Model C5BHDMIIRWP/SKU# .20065

HDMI™ and IR Repeater/Extender

- HDMI™ & IR repeater/extender wall plate over 2 CAT5, 5E, 6
- Extends HDMI™ signal over dual CAT5/5e/6 cable with resolution up to full 1080P
- Kit includes a transmitter, receiver, and two IR emitters
- HDCP compliant
- Sold in pairs



Model C5DWHIR/SKU# .18227

VGA to HDMI™ Converter

- Converts VGA video and stereo audio to HDMI™
- Supports highest video resolution 1280 x 1024; 1080p
- Supports 8bit p/channel (24bit all channel) deep color
- Supports uncompressed 2 channel audio such as LPCM
- Video amplifier bandwidth: 165MHz/1.65Gbps per channel (4.95Gbps all channels)
- Plug and play; Installs in seconds; no extensive configuring required
- HDMI™ compliant; HDCP pass-through
- Sold as each



Model CVTVGASA-H/SKU# .18222

HDMI™ over CAT5 Receiver

- Receive high-quality digital video and audio over dual CAT5; receiver only
- Receiver for C5DH only (SKU# .15697)
- Transmission range up to 164 feet/50 meters at hi-resolution 1080p
- HDMI™ and HDCP compliant
- Sold as each



Model C5HRX/SKU# .15698

High speed HDMI™ CAT5 Super Extender over dual CAT5e/6

- Transmit S-Video over CAT5 cable; supports HDMI™ up to full 1080p resolution and 24 bit deep color
- Transmits 1080p signal up to 197 feet/60 meters
- Video amplifier bandwidth: 165Mhz and up to 1.65Gbps
- Uses CAT5e or CAT6 cable to substitute for HDMI™ cable to achieve long distance transmission without signal degradation
- Auto-adjustment of feedback, equalization, and amplification. User does not need to adjust these variables to compensate for the length of the cable
- Sold in pairs



Model C5DHX/SKU# .17942

HDMI™ Repeater/Extender

- Extends HDMI™ cable distance up to 131 feet / 40 meters; cascadable to distances up to 475.7 feet/145 meters
- HDTV resolution up to full 1080p; 2k, 1440P graphics and up to 1920 x 1200 computer resolution with up to 36-bit deep color
- Video amplifier bandwidth: 225MHz with speed up to 6.75Gbps
- Supports DDWG standard for HDMI™ compliant monitors/HDCP compliant
- Sold as each



Model C5DHXA/SKU# .17941

HDMI™ EXTENDERS AND BALUNS (CONTINUED)

HDMI™ CAT5 Extender

- Extends HDMI™ signal over two CAT5/5e/6 cables
- High quality digital video and audio over CAT5
- Transmit up to 230 feet/70M at 1080i
- 98 feet/30M at 1080p resolution
- No power needed within 98 feet/30M
- External power supply needed at ranges greater than 98 feet/30M
- HDCP compliant
- Sold as pairs



Model C5DHE/SKU# .16244

HDMI™ Extender

- Extends any single HDMI™ source up to 98 feet (30 meters)
- Resolution up to 1080P (1920 x1080)
- Video amplifier bandwidth up to 4.95Gbps
- Great for home entertainment, high quality multimedia, video conferencing, broadcasting, and classrooms
- Power supply included
- Sold as each



Model BF3311/SKU# .15098

Component Video to HDMI™ Converter

- Converts component analog video and analog/digital audio to HDMI™
- Converts the component video signal to HDMI™ at the resolution of the component video source. If the source is set to 480i, 720p, 1080i, or 1080p, then it will convert to HDMI™ at the same corresponding resolution
- Allows older analog devices to be integrated seamlessly into the modern home theater
- Built-in local component video loop output w/stereo/digital (SPDIF) audio
- Sold as each



Model CVTRCV-H/SKU# .18221

S-Video/Audio Balun

- S-Video/Audio signal transmission over CAT5 cable
- 2 RCA connectors (for stereo audio) plus 4-pin mini din (for S-Video) to RJ45 female
- Transmit up to 984 feet/300 meters in color via CAT5
- Sold in pairs



Model C5SVA/SKU# .11086

S-Video Balun

- Transmits S-Video over CAT5 cable
- Transmits up to 984 feet/300 meters via CAT5 cable
- S-Video balun designed as a fast, easy, cost-effective means of connecting S-Video using CAT5 (RJ45) instead of coax
- Sold in pairs



Model C5SV/SKU# .11076

TECH TIPS

Most baluns are as simple as plug and play, requiring no extensive configuration.

CAT5/6 baluns allow VGA computer monitors to be connected long distances from the PC via CAT5/6 cables.

Use VGA baluns to extend touch screens or home automation control panels up to 984FT/300M.

Power supplies for both the transmitter and receiver are included in all DirectConnect® active baluns.

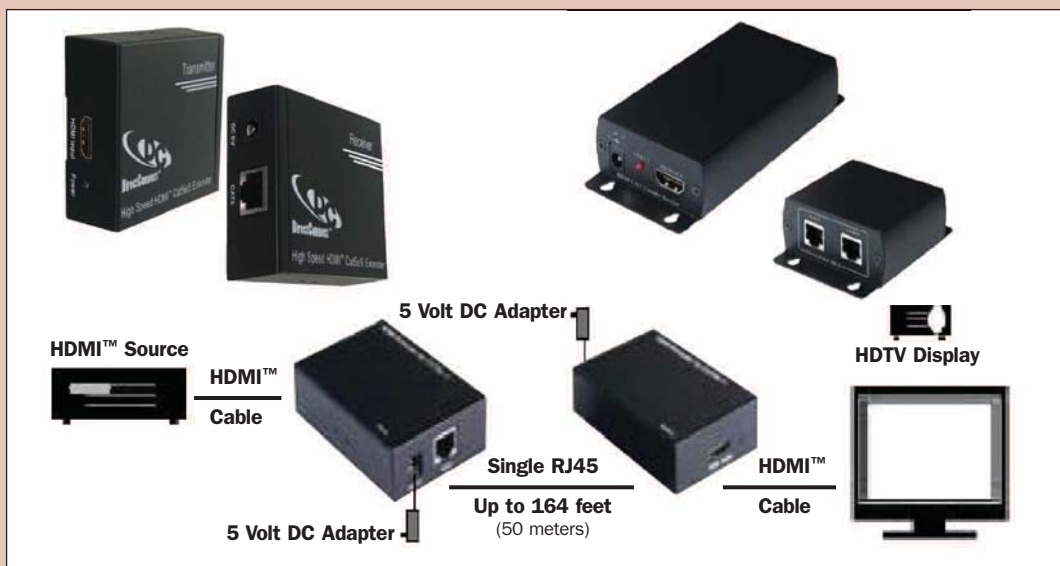

VIDEO BALUNS/EXTENDERS VGA

VGA and Audio over CAT5

- 1 in 5 out distribution amplifier
- Transmit a VGA signal up to 984 feet/300 meters via a CAT5 cable
- Supports up to 1600 x 1200 @ 85Hz
- Built-in contrast and brightness adjustment
- Includes transmitter, receiver, and power supply
- Sold in pairs



Model C5VGAA5P/SKU# .16251

VGA to CAT5 Extension Kit

- Extends a VGA signal long distances up to 443 feet/135 meters via CAT5 cable
- Supports up to 1280 x 1024
- Works with desktop PC, projectors, and plasma displays
- Active; power supply included
- Sold in pairs



Model C5VGAP/SKU# .12349

VGA to High-Speed HDMI™ Converter

- Converts VGA video and stereo audio to HDMI™
- Supports highest video resolution 1280x1024; 1080p
- Supports 8bit per channel (24bit all channel) deep color
- Supports uncompressed 2 channel audio such as LPCM
- Video amplifier bandwidth: 165MHz/1.65Gbps per channel (4.95Gbps) all channels
- High-speed HDMI™ compliant
- HDCP pass-through
- Sold as each



Model CVTVGASA-H/SKU# .18222

VGA and Audio over CAT5 Extender

- Distribution amp that transmits VGA and audio over CAT5 up to 984 feet/300 meters
- Single input; dual output: 1 VGA loop output for local, plus 1 CAT5 (RJ45) output
- Supports up to 1600x1200 @85Hz
- Built in contrast, brightness adjustment at receiver
- Power supplies included
- Sold in pairs



Model C5VBAA2P/SKU# .16250

VGA and Audio over CAT5 Extender

- Extends and distributes VGA and audio over CAT5 up to 984 feet/300 meters
- Dual outputs at the transmitter; 1 VGA loop output for local plus 1 CAT5 (RJ45) output for the remote side
- Supports up to 1600 x 1200 @ 85Hz
- Built in equalization and gain adjustment
- Sold in pairs



Model C5VBAA3P/SKU# .13940

VGA and RS232 over CAT5

- Transmits VGA and RS232 data over CAT5 up to 984 feet/300 meters without signal loss
- Dual outputs at the transmitter; 1 VGA output for local plus 1 CAT5 (RJ45) output for the remote side
- Supports up to 1600 x 1200 @ 85Hz
- Perfect for touch screen or automation control applications; send video images to a projector from long distances
- Sold in pairs



Model C5VGARS/SKU# .14006

VGA over CAT5 Balun

- Transmit VGA data over CAT5 up to 984 feet/300 meters
- Supports up to 1600 x 1200 @ 85Hz
- Built in contrast and brightness adjustment
- Plug and play: Installs in seconds; no extensive configuration required
- Sold in pairs



Model C5VGAV/SKU# .13306

VGA to Composite Video Converter

- Connects VGA output to existing TV
- Dual output ports: composite video (BNC) and VGA (DB15)
- Resolutions support: 640x480 (up to 85 Hz) 800x600 (up to 85 Hz), and 1024x768 (up to 75 Hz)
- Video standards: NTSC/NTSC-EIAJ/PAL/PAL-M/PAL-N/SECAM
- Image controls: Horizontal and vertical size, brightness, contrast, hue, saturation, sharpness and on-screen display background
- Sold as each



Model CVTVGA-V/SKU# .18218

VGA over CAT5 Extender

- Extends VGA signal over CAT5 up to 984 feet/300 meters
- Supports up to 1600 x 1200 resolution @ 85Hz
- 4 Port
- Dual output; 1 VGA loop output for local; plus 4 x CAT5 RJ45 output
- Built-in contrast and brightness control
- Power supplies included
- Sold in pairs



C5VGA4P/SKU# .13307

VGA to CAT5 Passive Extender Kit

- Transmit VGA over CAT5 up to 1,969 feet/600 meters via CAT5 STP or UTP cable
- Connects VGA output to an existing TV
- Passive; no power needed
- Sold in pairs



Model C5VGA/SKU# .11075

COMPONENT VIDEO BALUNS AND SWITCHERS

Component Video and Digital/Analog Audio Wall Plate Balun

- Transmits component video and digital/analog audio signals via single CAT5 up to 500 ft/150 meters at 720p/1080i
- Supports 1080i
- 12V output to supply power to other devices
- Converts digital to analog or analog to digital
- Sold in pairs



Model C5WRCVADA/SKU# .16167

4X2 Component Video Switcher

- Connect up to four A/V sources to two monitors
- HDTV compatible at 480i, 720p, 1080i, 1080p
- Expands both stereo audio and video inputs
- Sold as each



Model 42AVCOMP5W/SKU# .16254

1X9 Component Video Balun

- Extend and distribute one component video and digital audio signal to nine HDTV displays up to 984 feet/300 meters over CAT5 cable
- Supports HDTV signal: 480i, 480p, 720p, 1080i, 1080p
- One loop output allows cascading several units for larger video wall displays
- Rack mount
- Sold as each



Model C5RCVX9/SKU# .14003

Component Video/Digital Audio over CAT5 Extender

- Designed to transmit component video and digital audio over one CAT5 cable up to 984 feet/300 meters for video and 590 feet/180 meters for digital audio
- Supports HDTV signal: 480i, 480p, 720p, 1080i
- Passive; no power required
- Sold in pairs



Model C5RCVDA/SKU# .13962

Component Video/Digital Audio over CAT5 Extender

- Designed to extend component video and digital audio over one CAT5 cable up to 984 feet/300 meters for both video and audio
- Supports HDTV signal: 480i, 480p, 720p, 1080i
- Active type with external power
- Digital Audio: coaxial or optical interface
- Offers a high quality component video signal for use on plasma and LCD displays
- Sold in pairs



Model C5RCVHD/SKU# .14002

Component Video and Digital Audio CAT5 Balun with Chainable Output

- Extends component video and stereo/digital audio over single CAT5
- Long range transmission up to 984 feet/300 meters
- Works with C5RCVADAT as receiver for extra remote component video display equipment and audio
- Supports hi-resolution up to 1080p
- Built in equalization and gain adjustment
- Digital transmission on analog stereo audio for undistorted sound (Dolby Digital, AC3, DTS passed through)
- Sold as each



Model CRCVDAT/SKU# .18225

Component Video/Digital Audio CAT5 Balun with Chainable Output

- Extends component video and stereo/digital audio over single CAT5 cable
- Long range transmission up to 984 feet/300 meters
- Supports digital and analog audio
- Supports hi resolution up to 1080p
- Built in equalization and gain adjustment
- Digital transmission on analog stereo audio for undistorted sound (Dolby Digital, AC3, DTS passed through)
- Sold in pairs



Model C5RCVADAT/SKU# .18224

Active Audio and Video Receiver and Transceiver over CAT5/6

- Transmits a color video signal and data signal up to 4,921 feet / 1500 meters; transmits a black and white video signal and data signal up to 7,874 feet/2,400 meters over CAT5/6
- Built-in transient protection
- Sold in pairs



Model C5AVTP/SKU# .13069

Component Video to CAT5 Long Range Extender

- Transmits one component video signal (RGB) to three female BNC connectors or one CAT5/6 up to 1,969 feet/600 meters
- Simple plug and play connectivity
- Sold in pairs



Model C5BVX3RGB/SKU# .10949

Component Video over CAT5 Extender

- Transmit component video long distances over CAT5; up to 1,969 feet/600 meters
- Supports HDTV signal: 480i, 480p, 720p, 1080i, 1080p
- Passive, no power required
- Sold in pairs



Model C5RCV/SKU# .12669

AUDIO, COMPONENT AND COMPOSITE VIDEO BALUNS

Component Video to HDMI™ Converter

- Converts the component video signal to HDMI™ at the resolution of the component video source. If the source is set to 480i, 720p, 1080i, or 1080p, then it will convert to HDMI at the same corresponding resolution
- Allows older analog devices to be integrated seamlessly into the modern home theater
- Built-in local component video loop output w/stereo/digital(SPDIF) audio
- Sold as each



Model CVTRCV-H/SKU# .18221

Active Video Extender

- Transmits a full motion color or black/white video signal and data signal long distances up to 4,921 feet/1,500 meters over CAT5/6
- Video input: one female BNC and terminal block
- Low, mid, high-level settings
- 12V power supply included
- Sold each



Model C5BV/SKU# .9017

Component Video and Digital Audio Wall Plate Balun

- Transmit component video signal via passive wall plate extender
- Three RCA female to RJ45 female (Y, Pb, Pr) and digital audio
- Extends up to 984 feet/300 meters over CAT5 cable
- Supports HDTV signal: 480i, 480p, 720p, 1080i, 1080p
- Passive; no power required
- Wall plate dimensions: 4.5" (115mm) x 2.8" (71mm)
- Sold in pairs



Model C5WRCVDA/SKU# .16168

Video Hub

- Transmits four video signals over a single CAT5/6
- Passive video hub; 4 BNC female to one CAT5 (RJ45) female
- Transmits video up to 1,969 feet/600 meters (color 1,312 feet/400 meters)
- Sold each



Model C5BVX4/SKU# .9538

Dual Audio and Video Transceiver

- Transmits dual audio and video signals up to 984 feet/300 meters over a single CAT5/6
- 4 RCA female to 1 CAT5 (RJ45)
- Sold in pairs



Model C5RVRSA/SKU# .12415

Digital Audio Transceiver

- Designed to transmit digital audio up to 590 feet/180 meters over a single CAT5/6 cable
- Sold in pairs



Model C5RMA/SKU# .13999

Passive Audio and Video Transceiver over CAT5

- Transmits a color video signal and data signal up to 1,312 feet/400 meters in color; transmits a black and white video signal and data signal up to 1,968 feet/600 meters over CAT5/6
- BNC female with stereo RCA
- Passive; no power required
- Sold in pairs



Model C5BVRSA/SKU# .12725

Video Transceiver

- Transmits a color camera video signal up to 1,312 feet or 400 meters over a single CAT5/6; transmits a black and white video signal up to 1,968 feet/600 meters over a single CAT5/6
- Male BNC to CAT5/6 (RJ45) female
- Screw terminals and low voltage power pigtail
- Passive; no power needed
- Sold each



Model C5BVP/SKU# .12898

Stereo Audio/Video Extender

- Extends audio and video signal over CAT5/6
- Decorator wall plate allows extension of a standard audio/video signal through the wall
- Sold each



Model C5WRVRSA/SKU# .14001

Audio Transceiver

- Twisted pair audio ground loop isolator; helps eliminate audio ground loop issues
- RCA female to 2 pin screw terminal
- 20Hz to 20Khz bandwidth
- Available for 75-120 ohm cable
- Sold in pairs



Model C5RSA/SKU# .14000

USB AND RS232 CONTROL IP/POE

IP over CAT5/6 Extender

- Extends IP over CAT5/6 up to 3,937 feet/1200 meters
- Commonly used to extend IP camera signals long distances over CAT5/6
- Sold in pairs



Model C5IP/SKU# .17183

RS232 to RS485 Converter Output

- Easily converts RS232 to RS485
- RS485/RS422 output option; terminal or RJ11
- Extends up to 3,937 feet/1200 meters
- Supports transfer speeds of up to 115.2Kbps
- Bi-directional
- Power supply included
- Sold as each



Model CVTRS2-4BD/SKU# .12414

RS232 to RS485 Converter

- 1X8; 1 in 8 out; use CAT5/6 cable instead of VGA cable to transmit distances up to 3,937 feet/1200 meters over single CAT5/6
- Supports up to 1600 x 1200 @ 85Hz
- Rack mountable
- Power supply included
- Sold as each



Model CVTRS2-4X8/SKU# .14005

RS232 to RS485 Converter

- Easily converts RS232 to RS485
- DB9 female connector to 2 wire block
- Auto switching baud rate speeds up to 115,200 over a distance of 3,937 feet/1200 meters
- Sold as each



Model CVTRS2-4/SKU# .11077

USB over CAT5/6 Extender

- Extends four USB devices up to 164 feet/50 meters over CAT5; extend USB peripherals such as keyboards, mouse, cameras, etc.
- USB1.1 compliant
- Passive
- LED indicator
- Sold in pairs



Model C5UX4/SKU# .14974

Easy POE – Passive

- Easy Power Over Ethernet
- Provides power to network devices
- Passive
- Sold as each



Model C5POE/SKU# .18223

USB to RS485 Converter

- USB to RS485 interface converter
- Add additional COM ports to computers through existing USB ports
- Auto switching baud rate; speed up to 115,200 baud over a distance of 3,937 feet/1200 meters
- Powered by PC
- Connect/disconnect without reboot
- Software drivers included
- USB 2.0 compliant
- Sold as each



Model C5RSU/SKU# .13305

5V VDC 2 Amp Power Supply

- For use with 12V 2A cameras and baluns
- Pigtail design
- Sold as each



Model C5BPS/SKU# .18139

SPEAKERS/IN-CEILING AND IN-WALL

8" 2-Way In-Ceiling Speaker

- 8" 2-way Kevlar woofer with ¾" pivoting tweeter
- Impedance: 8 ohms
- Frequency Response: 40Hz-20KHz
- Power Handling: 50-100 watts @ 4 ohms
- Maximum output: 100 watts
- Magnet Size: 3.1" x 1.5" x 0.59"
- Magnet Weight: 10 oz
- 5 year warranty



Model IW8C/SKU# .20137

6½" Rectangle In-Wall Speaker

- 6½" aluminum driver with ¾" silk and titanium pivoting tweeter
- Impedance: 4 ohms
- Frequency Response: 46Hz-20KHz
- Power Handling: 50-100 watts @ 4ohms
- Maximum output: 100 watts
- Magnet Size: 3.1" x 1.5" x 0.59"
- Magnet Weight: 10 oz
- 5 year warranty



Model IW6.5S/SKU# .14130

8" Rectangle In-Wall Speaker

- 8" Kevlar driver with ¾" silk and titanium pivoting tweeter
- Impedance: 8 ohms
- Frequency Response: 40Hz-20KHz
- Power Handling: 50-100 watts @ 4 ohms
- Maximum output: 100 watts
- Magnet Size: 3.1" x 1.5" x 0.59"
- Magnet Weight: 10 oz
- 5 year warranty



Model IW8S/SKU# .20138

6½" Round In-Ceiling Speaker

- Economy Line
- Impedance: 8 ohms
- Polypropylene woofer and ½" adjustable tweeter
- Frequency Response: 70Hz-20KHz
- Power Handling: 40-80 watts @ 8 ohms
- Paintable white frame and perforated metal grill
- Magnet Size: 3.15"x1.57"x .59
- Magnet Weight: 10 oz
- 5 year warranty

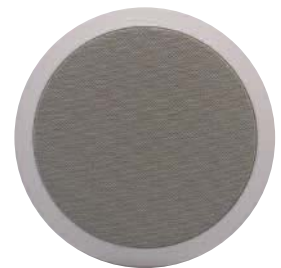

Model IW6.5EC/SKU# .18212

5¼" L/C/R Speaker

- 5¼" fiber woofer and 1" silk dome tweeter
- Impedance: 4 ohms
- Frequency Response: 56Hz-20KHz
- Power Handling: 40-80 watts @ 4 ohms
- Maximum output: 80 watts
- Installs vertically or horizontally
- Magnet Size: 3.15" x 1.25" x 0.59" x 2"
- Magnet Weight: 11.16 oz
- 5 year warranty



Model IW5CEN/SKU# .18213

IW65R Replacement Grills

- Aluminum replacement grills for IW65R
- Round design
- Sold in pairs



Model IW6.5R (Replacement Grills)/SKU# .11896

6½" Round In-Ceiling Speaker

- 6½" aluminum driver with ¾" silk and titanium pivoting tweeter
- Impedance: 8 ohms
- Frequency Response: 48Hz-20KHz
- Power Handling: 80-120 watts @ 8 ohms
- Maximum output: 120 watts
- Magnet Size: 3.9" x 1.8" x 0.59"
- Magnet Weight: 16 oz
- 5 year warranty



Model IW6.5C/SKU# .11315

IW65S Replacement Grills

- Aluminum replacement grills for IW65S
- Rectangle design
- Sold each



Model IW6.5S (Replacement Grills)/SKU# .16216

SPEAKERS INDOOR/OUTDOOR

8" 2-Way Indoor/Outdoor Speaker

- Impedance: 8 ohms
- Frequency Response: 96Hz-20KHz
- Power Handling: 70-140 watts @ 8 ohms
- Maximum output: 140 watts
- Installs vertically or horizontally
- Magnetic Size: 4.33" x 2.36" x 0.78"
- Magnetic Weight: 23.5oz
- 5 year warranty



**Model I08W (White)/
SKU# .18146**



**Model I08B (Black)/
SKU# .18147**

5¼" 2-Way Indoor/Outdoor Speaker

- Impedance: 8 ohms
- Frequency Response: 116Hz-20KHz
- Power Handling: 40 – 80 watts @ 8 ohms
- Maximum output: 80 watts
- May be installed vertically or horizontally
- Magnet Size: 3.15" x 1.57" x 0.59"
- Magnet Weight: 10 oz
- 5 year warranty

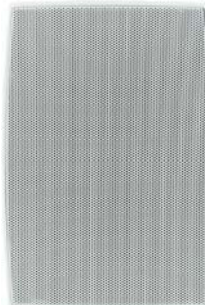

**Model I0525W (White)/
SKU# .18142**



Model I0525B (Black)/SKU# .18143

8" 2-Way Indoor/Outdoor Rock Speaker

- 8" poly injected rubber edge woofer
- 3mm dome tweeter
- Maximum output: 80 watts
- Magnet: 13.3oz
- Designed for indoor or outdoor use
- 6FT AWG 14G attached burial cable



**Model I0ROC8-SB
SKU# .20141** Sandy Brown Rock



**Model I0ROC8-GY
SKU# .20142** Grey Granite Rock

6½" 2-Way Indoor/Outdoor Speaker

- Impedance: 8 ohms
- Frequency Response: 115Hz-20KHz
- Power Handling: 50-100 watts @ 8 ohms
- Maximum output: 100 watts
- Installs vertically or horizontally
- Magnet Size: 3.9" x 2.36" x 0.66"
- Magnet Weight: 15.1oz
- 5 year warranty



**Model I065W (White)/
SKU# .18144**



Model I065B (Black)/SKU# .18145

3½" 2-Way Indoor/Outdoor Speaker

- Impedance: 8 ohms
- Frequency Response: 125Hz-20KHz
- Power Handling: 30-60 watts @ 8 ohms
- Maximum output: 60 watts
- Magnet Size: 2.75" x 1.26" x 0.59"
- Magnet Weight: 8 oz
- May be installed vertically or horizontally
- 5 year warranty



**Model I035B (Black)/
SKU# .18141**



Model I035W (White)/SKU# .18140

6½" 2-Way Indoor/Outdoor Rock Speaker

- 6½" poly injected rubber edge woofer
- 3mm dome tweeter
- Maximum output: 80 watts
- Magnet: 13.3oz
- Designed for indoor or outdoor use
- 6FT AWG 14G attached burial cable



**Model I0ROC6-SB
SKU# .20140** Sandy Brown Rock



**Model I0ROC6-GY
SKU# .20143** Grey Granite Rock

MOUNTS AND BRACKETS

42" – 70" LCD/PDP Articulating Mount

- Flat, tilt, or articulating LCD/PDP mount
- Mount designed to tilt from -5° to 15° with easy tilt system
- Also designed to pull away from the wall 22.83"
- Safely supports 42"-70" LCD TV, flat panel monitors, or plasma display panels
- Distance from wall 3.05"/77.5mm
- Supports up to 165 lbs
- 800x600 VESA
- Lock and level included
- UL rated
- Black



Model FP4270AT-B/SKU# .15762

42" – 70" LCD/PDP Tilt Mount

- Tilt LCD/PDP mount
- Mount designed to tilt from -5° to 15° with easy tilt system
- Safely supports 42"-70" LCD TV, flat panel monitors, or plasma display panels
- Distance from wall 3.058/77.5mm
- Supports up to 165 lbs
- 800 x 600 VESA
- Lock and level included
- UL rated
- Black



Model FP4270T-B/SKU # .15761

42" – 70" LCD/PDP Flat Fixed Mount

- Flat fixed LCD/PDP mount
- Mount designed to operate in a fixed position
- Safely supports 42"-70" LCD TV, flat panel monitors, or plasma display panels
- Distance from wall 1.18"/30mm
- Supports up to 165 lbs
- 800x600 VESA
- Lock and level included
- UL rated
- Black



Model FP4270F-B/SKU # .15760

42" – 65" LCD/PDP Tilt Mount

- Tilt LCD/PDP mount
- Mount designed to tilt from -5° to 15° with easy tilt system
- Safely supports 42"-65" LCD TV, flat panel monitors, or plasma display panels
- Distance from wall 3.27"/83mm
- Supports up to 132 lbs
- 800x600 VESA
- Level included
- UL rated
- Black



Model FP4265T-B/SKU # .18297

TECH TIPS

DirectConnect® Mounts

DirectConnect® provides innovative mounting solutions based on feedback from you – the professional. By listening to you, **DirectConnect®** has created a full line of UL rated mounts that are high quality, functional, easy to install, and include all the necessary parts needed for a seamless installation. We supply products for residential and commercial mounting solutions that are aesthetically pleasing at affordable prices.

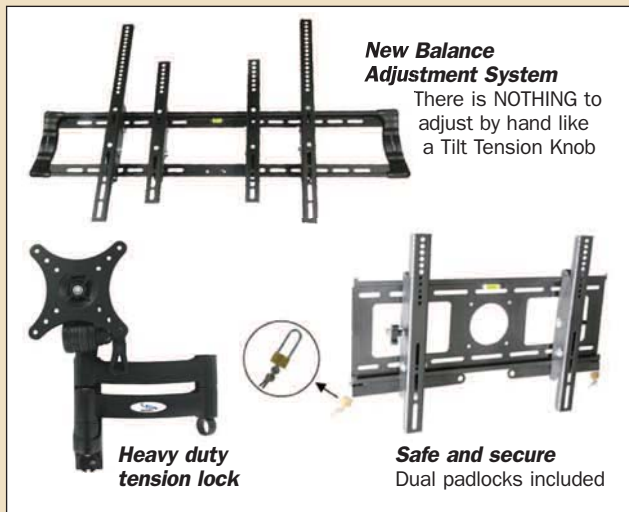

42" – 65" LCD/PDP Flat Fixed Mount Kit

- Mount designed to operate in a fixed position
- Safely supports 42"-65" or 26"-42" (with included extension arms) LCD TV, flat panel monitor or plasma display panel
- Includes 430MM and 630MM brackets
- Supports up to 132 lbs
- 800X600 VESA
- Level included
- UL rated
- Black

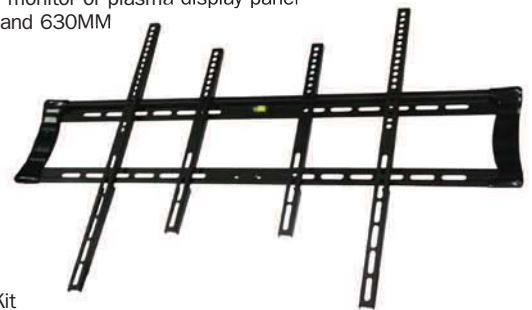

Model FP4265F-B Kit
(.18301 & .18295), SKU# .18986

42" – 65" LCD/PDP Tilt Mount Kit

- Mount designed to operate in a fixed or tilt position
- Safely supports 42"-65" LCD TV, flat panel monitor or plasma display panel
- Includes 430MM and 630MM brackets
- Supports up to 132 lbs
- 800X600 VESA
- Level included
- UL rated
- Black



Model FP4265T-B Kit
(.18542 & .18297), SKU# .18987

MOUNTS AND BRACKETS (CONTINUED)

26" – 50" LCD/PDP Tilt Mount

- Tilt LCD/PDP mount
- Mount designed to tilt from -5° to 15° with easy tilt system
- Safely supports 26"-50" LCD TV, flat panel monitors, or plasma display panels
- Distance from wall 3.05"/77.5mm
- Supports up to 165 lbs
- 600x400 VESA
- Lock and level included
- UL rated
- Black

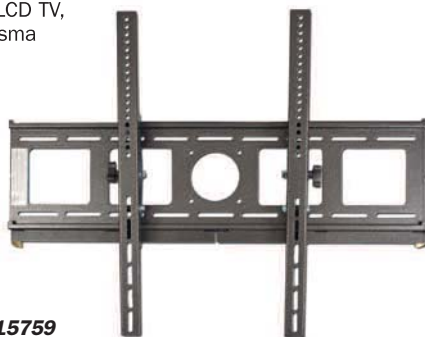

Model FP2650T-B/SKU # .15759

26" – 50" LCD/PDP Flat Fixed Mount

- Flat fixed LCD/PDP mount
- Safely supports 26"-50" LCD TV, flat panel monitors, or plasma display panels
- Distance from wall 1.18"/30mm
- Supports up to 165 lbs
- 600x400 VESA
- Lock and level included
- UL rated
- Black



Model FP2650F-B/SKU# .15758

32" – 50" LCD/PDP Flat Fixed Mount

- Flat ultra thin fixed LCD/PDP mount
- Design sets the TV less than one inch from the wall
- Distance from wall 0.63"/16mm
- Safely supports 32"-50" LCD TV, flat panel monitors, or plasma display panels
- Supports up to 99 lbs
- 600 x 400 VESA
- Lock and level included
- UL rated
- Black



Model FP3250FUT-B/SKU# .19455

26" – 42" LCD/PDP Tilt Mount

- Tilt LCD/PDP mount
- Mount designed to tilt from -5° to 15° with easy tilt system
- Safely supports 26"-42" LCD TV, flat panel monitor or plasma display panel
- Distance from wall 3.27"/83mm
- Supports up to 110 lbs
- 500x400 VESA
- Level included
- UL rated
- Black



Model FP2642T-B/SKU# .18296

42" – 65" LCD/PDP Flat Fixed Mount

- Flat ultra thin fixed LCD/PDP mount
- Design sets the TV less than one inch from the wall
- Distance from wall 0.71"/18mm
- Safely supports 42"-65" LCD TV, flat panel monitors, or plasma display panels
- Supports up to 132 lbs
- 800 x 600 VESA
- Lock and level included
- UL rated
- Black



Model FP4265FUT-B/SKU# .19457

26" – 42" LCD/PDP Flat Fixed Mount

- Flat fixed LCD/PDP mount
- Safely supports 26"-42" LCD TV, flat panel monitors, or plasma display panels
- Distance from wall 1.004"/25mm
- Supports up to 132lbs
- 500x400 VESA
- Level included
- UL rated
- Black



Model FP2642F-B/SKU # .18294

42" – 65" LCD/PDP Flat Fixed Mount

- Flat fixed LCD/PDP mount
- Safely supports 42"-65" LCD TV, flat panel monitors, or plasma display panels
- Distance from wall 1.04"/25.5mm
- Supports up to 132 lbs
- 800x600 VESA
- Level included
- UL rated
- Black



Model FP4265F-B/SKU# .18295

26" – 32" LCD/PDP Swivel/Tilt/Extend Mount

- Designed to easily swivel, tilt, and extend
- Safely supports 26"-32" LCD TV, flat panel monitor or plasma display panel
- Supports up to 55 lbs
- 200x200 VESA
- UL rated
- Black



Model FP2232STE2-B/SKU# .19626

MOUNTS AND BRACKETS (CONTINUED)

10" – 24" LCD/PDP Swivel/Tilt Mount

- Designed to easily swivel, tilt, and extend
- Safely supports 10"-24" LCD TV, flat panel monitor, or plasma display panel
- 75 X 75 and 100 X 100 VESA
- UL rated
- Black



Model FP1024STE1-B/SKU# .19983

Flat Universal Plate

- Flat universal adapter plate for TV mounts
- VESA change plate
- 100 VESA
- Black

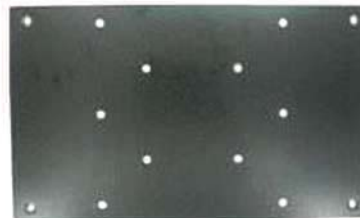

Model FPUAP-B/SKU# .16963

Universal Projector Mount

- Provides tilt and rotation capabilities for ceiling projectors
- Drops projector mount plate down 9.5"/400mm
- Tilts ± 15°
- Rotates 360°
- Max load capacity 22 lbs/10Kg
- Easy to install
- Silver



Model PRMU-1-S/SKU # .16962

Short Tilt Arms for 26" – 36" TVs

- Designed to convert TV mounts to support 26"-36" size LCD TV, flat panel monitors, or plasma display panels
- Fits the FP2642TB/FP4265TB mounts
- Sold in pairs
- Black



Model FP26BR-ST/SKU# .18542

Universal Projector Extension

- Extension pole designed to lower projector down from the ceiling
- Drops projector mount plate down 15.75"/400mm
- Fits spyder-type projector mounts
- Silver



Model PRX400MM/SKU# .16965

Short Fixed Arms for 26"- 42" TVs

- Designed to convert TV mounts to support 26"-42" TVs
- Fits the FP2642FB/FP4265FB mounts
- Sold in pairs
- Black



Model FP26BR-SF/SKU# .18301

Universal Projector Extension

- Extension pole designed to lower projector down from the ceiling
- Drops projector mount plate down 7.87"/200mm
- Fits spyder-type projector mounts
- Silver



Model PRX200MM/SKU# .16964

Hinged Wall Bracket

- Secures a patch panel to the wall for a neat professional installation
- Hinged wall bracket designed to mount to a 24 port CAT5 or voice patch panel
- Black



Model	Rack Size	SKU#
HWB1	1 space	.6091
HWB2	2 space	.4824
HWB3	3 space	.6089
HWB4	4 space	.14789

EQUIPMENT RACKS

Equipment Rack

Ships pre-assembled Equipment rack includes:

- Removable side panels
- Casters
- Two adjustable shelves
- Back wall plate bracket
- Max load 130 lbs



Model RM9U/SKU# .19180
19.7" H x 19.7" W x 17.7" D

Contractor Series Equipment Rack

Ships pre-assembled Equipment rack includes:

- Removable sides and back panel
- Locking glass front door

- Adjustable shelves (optional)
- Casters and cooling fan
- Max load 1300 lbs



Model RM18U/SKU# .19181

35.50" H
x 23.60" W
x 23.60" D



Model RM27U/SKU# .19182

53.70" H
x 23.60" W
x 23.60" D

Professional Series Equipment Rack

Easy to assemble Equipment rack includes:

- Locking glass front door
- Thermostat
- Power supply
- Adjustable casters
- Two fan system
- Removable sides
- Removable back panel
- Max load 1700 lbs



Model RACK29U/SKU# .19929

57.50" H
x 23.675" W
x 23.675" D



Model RACK38U/SKU# .19930

70.86" H
x 23.675" W
x 23.675" D



Model RACK42U/SKU# .19931

78.75" H
x 23.675" W
x 23.675" D

Equipment Rack Accessories

RF2U – Fan

SKU# .19918



R THERM – Thermostat

SKU# .19919



RPS – Power Supply

SKU# .19921



RFS2UV – Vented Shelf

SKU# .21134



RSS – Sliding Shelf

SKU# .19922



SKU#	Model	Description	SKU#	Model	Description	SKU#	Model	Description
.19925	RB1U	Blank	.19923	RFS	1U shelf	.19918	RF2U	Rack fan
.19926	RB2U	Blank	.21133	RFS1UV	1U vented shelf	.19919	R THERM	Thermostat
.19927	RB3U	Blank	.21134	RFS2UV	2U vented shelf	.19920	RCASTER	Caster w/brake
.19928	RB4U	Blank	.21135	RFS3UV	3U Vented shelf	.19921	RPS	Power strip
.19924	RLB	Lacing bar	.19922	RSS	Sliding shelf	.19932	RHW	Hardware pack

SCREENS

Permanent Fixed-Frame Cinema Screen

- PS Series HDTV high-contrast cinema fabric w/ 1.0 gain and 160° viewing angle
- Projection surface's backside is reinforced with a special composite PVC material
- Designer velvet wrapped high-quality aluminum alloy frame
- Adjustable tension system ensures screen display is completely flat at all times
- Perfect for home theaters, media rooms, and conference rooms
- Easy installation and set-up

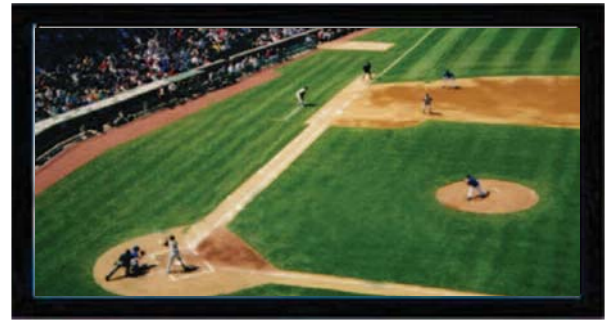

Screen size	Format	Viewing area	Overall Dimensions	Model	SKU#
77"	16:9	67" x 38"	73-15/32" Wide x 44-3/32" High	77FS16-9	.15867
84"	16:9	73" x 41"	79-9/16" Wide x 47-17/32" High	84FS16-9	.15868
92"	16:9	80" x 45"	86-9/16" Wide x 51-15/32" High	92FS16-9	.15869
92" Perforated	16:9	80" x 45"	86-9/16" Wide x 51-15/32" High	92FS16-9PF	.20405
92" Grey	16:9	80" x 45"	86-9/16" Wide x 51-15/32" High	92FS16-10GY	.15870
100"	16:9	87" x 49"	93-17/32" Wide x 55-13/32" High	100FS16-9	.15871
100" Perforated	16:9	87" x 49"	93-17/32" Wide x 55-13/32" High	100FS16-9PF	.20406
100" Curved	16:9	87" x 49"	93-17/32" Wide x 55-13/32" High	100FS16-9CV	.20411
106"	16:9	92" x 52"	98-3/4" Wide x 58-5/16" High	106FS16-9	.15872
106" Perforated	16:9	92" x 52"	98-3/4" Wide x 58-5/16" High	106FS16-9PF	.20413
106" Curved	16:9	92" x 52"	98-3/4" Wide x 58-5/16" High	106FS16-9CV	.20410
106" Grey	16:9	92" x 52"	98-3/4" Wide x 58-5/16" High	106FS16-10GY	.15873
112"	16:9	98" x 55"	100-31/32" Wide x 61-1/4" High	112FS16-9	.15874
112" Perforated	16:9	98" x 55"	100-31/32" Wide x 61-1/4" High	112FS16-9PF	.20407
120"	16:9	105" x 59"	110-15/16" Wide x 65-3/16" High	120FS16-9	.15875
120" Perforated	16:9	105" x 59"	110-15/16" Wide x 65-3/16" High	120FS16-9PF	.20408
120" Curved	16:9	105" x 59"	110-15/16" Wide x 65-3/16" High	120FS16-9CV	.20409
135"	16:9	118" x 66"	124" Wide x 72-17/32" High	135FS16-9	.15876
135" Curved	16:9	118" x 66"	124" Wide x 72-17/32" High	135FS16-9CV	.20412
150"	16:9	131" x 74"	137-3/32" Wide x 79-7/8" High	150FS16-9	.15877

Note: Sizes and specifications are subject to change without notice

Tab-Tension Cinema Integrated High-End Motorized Screen

- PS Series HDTV high-contrast cinema fabric w/ 1.0 gain and 160° viewing angle
- Heavy duty somfy systems tubular motor
- L-Bracket rail system allows easy setup; screen may be ceiling or wall mounted
- Adjustable tab-tension
- IR wireless remote system with built-in IR 12V trigger and RS232



Screen size	Format	Viewing area	Overall Dimensions	Model	SKU#
92"	16:9	80" x 45"	99.21" Wide x 70.00" Drop	92IMTS16-9R	.19780
100"	16:9	87" x 49"	106.38" Wide x 73.98" Drop	100IMTS16-9R	.19781
106"	16:9	92" x 52"	111.57" Wide x 76.89" Drop	106IMTS16-9R	.19782
120"	16:9	105" x 59"	123.78" Wide x 83.74" Drop	120IMTS16-9R	.19783
135"	16:9	118" x 66"	137" Wide x 90.86" Drop	135IMTS16-9R	.19784
150"	16:9	131" x 74"	149.92" Wide x 98.43" Drop	150IMTS16-9R	.19785

Note: Sizes and specifications are subject to change without notice

SCREENS (CONTINUED)

Designer Cyber Series Motorized Screen

- Designer curved aluminum alloy casing
- Heavy duty somfy systems tubular motor
- L-Bracket rail system allows easy setup
- Screen may be ceiling or wall mounted
- 4-layer matte white fabric with 1.0 Gain
- IR wireless remote system with built-in IR 12V trigger and RS232



Screen size	Format	Viewing area	Overall Dimensions	Model	SKU#
92"	16:9	80" x 45"	86.77" Wide x 71.26" Drop	92IMS16-9R	.19786
100"	16:9	87" x 49"	94.02" Wide x 75.67" Drop	100IMS16-9R	.19787
106"	16:9	92" x 52"	98.78" Wide x 78.62" Drop	106IMS16-9R	.19788
120"	16:9	105" x 59"	111.46" Wide x 81.54" Drop	120IMS16-9R	.19789
135"	16:9	118" x 66"	129.53" Wide x 86.73" Drop	135IMS16-9R	.19790
150"	16:9	131" x 74"	142.52" Wide x 94.09" Drop	150IMS16-9R	.19791

Note: Sizes and specifications are subject to change without notice

Designer Cyber Series Manual Screen

- Designer curved aluminum alloy casing
- Available with speed reduction and self-lock features
- L-Bracket rail system allows easy setup
- Screen may be ceiling or wall mounted
- 4-layer matte white fabric with 1.0 gain



Screen size	Format	Viewing area	Overall Dimensions	Model	SKU#
77"	16:9	67" x 38"	72.36" Wide x 70.86" Drop	77MANS16-9B	.15887
92"	16:9	80" x 45"	86.77" Wide x 71.26" Drop	92MANS16-9B	.15888
92" Self Lock	16:9	80" x 45"	86.77" Wide x 71.26" Drop	92MANS16-9BSL	.15889
106"	16:9	92" x 52"	98.78" Wide x 78.62" Drop	106MANS16-9B	.15890
106" Self Lock	16:9	92" x 52"	98.78" Wide x 78.62" Drop	106MANS16-9BSL	.15891
120"	16:9	105" x 59"	111.46" Wide x 81.36" Drop	120MANS16-9B	.15892

Note: Sizes and specifications are subject to change without notice

Screen Accessories

Accessory	Description	Model	SKU#
Wireless Power Relay	Synchro Wireless Power Relay Kit (only used with Integrated Motorized Screens)	WPRKIT	.20404
IR Sensor Kit	Added 12V trigger – for screens w/up/down switch only	IR12VT	.20437
RF Sensor Kit	For Use With Screens with up/down switch – not Integrated	RFKIT	.15897
12V Wireless Trigger	12V Wireless Trigger Kit (used with Integrated Motorized Screens)	12VWT	.19752
L-Bracket	Extra Bracket for Cyber Screens	Cyber L-Bracket	.16185
Ceiling Mount	Ceiling Mounts for Cyber Screens	Cyber Ceiling Mount	.16186

HIGH RESOLUTION DOME CAMERAS

High-Resolution Indoor/Outdoor Digital Dome Camera with Wireless Remote Control

- 1/4" Sony Super HAD Charge-Couple Device (CCD) to improve brightness sensitivity through improved light utilization
- 570 TV lines with auto-iris vari-focal lens (3.8mm – 38mm); 10X optical and 10X digital zoom lens
- True day/night capability; built-in 42-power infrared LEDs with Cadmium Sulfide Cells (CDS) sensors. The 42 built-in LEDs help illuminate objects at a distance in complete darkness while the CDS sensors allow the camera to change from day to night mode automatically
- Removes noise and ghosting effects with video DNR
- Cable through the mount for maximum versatility
- Wireless remote control included
- 12V DC power supply included
- Indoor/outdoor use
- Weather-resistant
- 2-yr warranty



Model HD-D570VE42 (Black)/SKU# .18200

High-Resolution Indoor/Outdoor Digital Dome Camera with Wireless Remote Control

- 1/3" Sony Super HAD Charge-Couple Device (CCD)
- 560 TV lines with auto focus lens (3.4mm-11mm)
- Built-in 35-power infrared LEDs with CDS sensors
- Removes noise and ghosting effects with DNR
- Cable through the mount for maximum versatility
- Spider-net resistant technology reduces insect obstructions
- Wireless remote control included
- On-board push buttons for easy set-up
- 12V DC power supply included
- Indoor/outdoor use
- Weather-resistant
- 2-yr warranty



Model HD-D560VDV35 (Black)/SKU# .18199

High-Resolution Indoor/Outdoor Digital Dome Camera

- 1/3" Sony Super HAD Charge-Couple Device (CCD)
- 560 TV lines with auto iris vari-focal lens (2.8mm-12mm)
- True day/night capability; built-in 20-power infrared LEDs with CDS sensors allow auto day/night switching
- Remove noise and ghosting effects with DNR
- Cable through the mount for maximum versatility
- Spider-net resistant technology reduces insect obstructions
- On-board push buttons for easy set-up
- 12V DC power supply included
- Indoor/outdoor use
- Weather-resistant
- 2-yr warranty



Model HD-D150 (White)/SKU# .15124

High-Resolution Indoor/Outdoor Digital Dome Camera

- 1/3" Sony Super HAD Charge-Couple Device (CCD)
- 560 TV lines with auto iris vari-focal lens (2.8mm-12mm)
- True day/night capability
- Remove noise and ghosting effects with DNR
- Cable through the mount for maximum versatility
- Controlled by on-board push buttons
- 12V DC power supply included
- Indoor/outdoor use
- Weather-resistant
- 2-yr warranty



Model HD-D160 (White)/SKU# .15125

High-Resolution Indoor Dome Camera

- 1/3" Sony Super HAD Charge-Couple Device (CCD) to improve brightness sensitivity through improved light utilization
- Provides up to 560 TV lines with auto-iris vari-focal lens (2.8mm – 12mm)
- True day/night capability; uses a mechanical IR cut filter switch. The mechanism places the filter in front of the sensor during daytime/color operation and removes it during low-light conditions to maximize infrared sensitivity
- Easily controlled by on-board push buttons for easy set-up
- Cable through the mount for maximum versatility
- 12V DC power supply included
- Designed for indoor use only
- Minimum illumination: 0.1 LUX
- 2-yr warranty



Model HD-D560VDV-BK (Black)/SKU# .18203
Model HD-D560VDV-WH (White)/SKU# .18202

High-Resolution Indoor Digital Dome Camera

- 1/3" Sony Super HAD Charge-Couple Device (CCD)
- Built-in 21-power infrared LEDs with CDS sensors
- 520TV lines with auto iris vari-focal lens (2.8mm-10mm)
- True day/night capability
- Cable through the mount for maximum versatility
- Removes noise and ghosting effects with DNR
- 12V DC power supply included
- Indoor use only
- Black
- 2-yr warranty



Model HD-D495-21IR (Black)/SKU# .20210

TECH TIPS

DirectConnect® offers a full line of cameras that deliver extraordinary performance and superior image quality for 24-hour day-to-day performance with the latest features at affordable prices.

Our standard camera line incorporates Sony's latest Super HAD CCD image pickup device with 3rd Generation DSP technology that captures the highest picture quality under the most extreme lighting conditions. The HAD CCD has twice the sensitivity and 6db greater smear rejection ratios than other CCD image pickup devices.

Auto Focus: Allows the camera to zoom in or out without the need to adjust a manual focus ring

CCD (Charge-coupled device): Allows for better light detection where high-quality image data is expected

CDS Sensor: Allows the camera to change from day to night mode automatically

DNR (Digital Noise Reduction): Helps reduce ghosting and noise effects from the video signal

Spider Net: Used to reduce cobwebs and insects by using an amplifier and speaker to generate a high frequency signal

OSD (On Screen Display): Allows on screen camera adjustments via on-board pushbuttons or wireless remote

HIGH RESOLUTION BULLET CAMERAS

High-Resolution Indoor/Outdoor Digital Bullet Camera

- 1/3" Sony Super HAD Charge-Couple Device (CCD)
- 560TV lines with auto iris vari-focal lens (3.4mm-11mm)
- True day/night capability; built-in 35-power infrared LEDs with Cadmium Sulfide Cells (CDS) sensors. The 35 built-in LEDs help illuminate objects at a distance in complete darkness while the CDS sensors allow the camera to change from day to night mode automatically
- Remove noise and ghosting effects with DNR
- Spider-net resistant technology reduces insect obstructions
- Cable through the mount for maximum versatility
- Wireless remote control included
- 5 button control located on the bottom of the camera
- IR dimmer control
- 12V DC power supply included
- Indoor/outdoor use
- Bullet design
- Weather-resistant
- 2-yr warranty



Model HD-Z560VDV35 (Black)/SKU# .18201

High-Resolution Indoor/Outdoor Digital Bullet Camera

- 1/3" Sony Super HAD Charge-Couple Device (CCD)
- 420TV lines with auto iris vari-focal lens (4mm-9mm)
- Color by day; black and white at night
- Cable through the mount for maximum versatility
- 12V DC power supply included
- Bullet design
- Indoor/outdoor use
- Weather-resistant
- 2-yr warranty



Model HD-618B (Black)/SKU# .15128
Model HD-618W (White)/SKU# .16958

High-Resolution Indoor/Outdoor Digital Bullet Camera

- 1/3" Sony Super HAD Charge-Couple Device (CCD)
- Built-in 56-power infrared LEDs with CDS sensors
- 560 TV lines with auto iris vari-focal lens (2.8mm-1.2mm)
- True day/night capability
- Cable through the mount for maximum versatility
- Removes noise and ghosting effects with DNR
- 12V DC power supply included
- Indoor/outdoor use
- Bullet design
- Weather-resistant
- 2-yr warranty



Model HD-D511 (White)/SKU # .15126

High-Resolution Indoor/Outdoor Digital Bullet Camera

- 1/3" Sony Super HAD Charge-Couple Device (CCD)
- 520 TV lines with 3.6mm fixed board lens
- True day/night capability
- Remove noise and ghosting effects with DNR
- Cable through the mount for maximum versatility
- 12V DC power supply included
- Indoor/outdoor use
- Bullet design
- Weather-resistant
- 2-yr warranty



Model HD-B365-231R (Black)/SKU# .19987

High-Resolution Indoor/Outdoor Digital Bullet Camera

- 1/3" Sony Super HAD Charge-Couple Device (CCD)
- Built-in 20-power infrared LEDs with CDS sensors
- 560 TV lines with auto iris vari-focal lens (2.8mm-1.2mm)
- True day/night capability
- Cable through the mount for maximum versatility
- 12V DC power supply included
- Indoor/outdoor use
- Weather-resistant
- 2-yr warranty



Model HD-D532 (White)/SKU# .15127

High-Resolution Indoor/Outdoor Digital Bullet Camera

- 1/3" Sony Super HAD Charge-Couple Device (CCD)
- Built-in 14-power infrared LEDs with CDS sensors
- 420 TV lines with 3.6mm fixed board lens
- True day/night capability
- Cable through the mount for maximum versatility
- 12V DC power supply included
- Indoor/outdoor use
- Weather-resistant
- 2-yr warranty



Model HD-606B (Black)/SKU #.15765

High-Resolution Indoor/Outdoor Digital Bullet Camera

- 1/3" Sony Super HAD Charge-Couple Device (CCD)
- Built-in 14-power infrared LEDs with CDS sensors
- 420 TV lines with auto iris vari-focal lens (2.8mm-1.2mm)
- True day/night capability
- 12V DC power supply included
- Indoor/outdoor use
- Bullet design
- Weather-resistant
- 2-yr warranty



Model HD-S602 (Black)/SKU# .18231

High-Resolution Indoor/Outdoor Digital Bullet Camera

- 1/3" Sony Super HAD Charge-Couple Device (CCD)
- 420TV lines with 3.6mm fixed board lens
- Featuring 12 built-in powered infrared LEDs
- True day/night capability
- Cable through the mount for maximum versatility
- 12V DC power supply included
- Indoor/outdoor use
- Weather-resistant
- Silver
- 2-yr warranty



Model HD-607S (Silver)/SKU# .15766

CAMERA ACCESSORIES

19" LCD Monitor w/Built In DVR

- All in one recording/monitoring solution
- LCD monitor with remote control
- Built-in 4 channel stand-alone DVR
- 320GB built in hard drive
- Triplex (live, playback, and rewind)
- High resolution (1280X1024)
- Built-in stereo speakers
- Network support



Model HD-5039EN/SKU # .16488

TFT Wrist Monitor

- 3.5" TFT LCD display
- Helps simplify the set-up of cameras and other video sources
- 960x234mm resolution
- 350:1 contrast ratio
- Battery and power supply not included



Model TFT35VM/SKU# .15643

Wall-Mounted Regulated Power Supply Center

- Designed to feed power to multiple cameras at the same time from one central location
- Up to 16 ports and 8 amps total usage
- Allows user the ability to switch between 12V and 24V
- LED indicators (Both power and ports)
- Power switch
- Metal cabinet with hinged door
- Optional A/C pigtail required
- 2 year warranty
- Sold each



Model P16P8ADC1224/SKU# .12419

Wall-Mounted Regulated Power Supply Center

- Designed to feed power to multiple cameras at the same time from one central location
- Up to 8 ports and dual 4 amp total usage
- Includes built-in 12V 3.3amp rechargeable battery (field serviceable)
- 12VDC
- Metal cabinet with hinged door
- Optional A/C pigtail required
- 2 year warranty
- Sold each



Model P8P4AU/SKU# .14983

Wall-Mounted Regulated Power Supply Center

- Designed to feed power to multi cameras at the same time from one central location
- Up to 8 ports and 4 amps total usage
- Allows user the ability to switch between 12V and 24V
- Metal cabinet with hinged door
- Power indicator
- Fused
- Optional A/C pigtail required
- 2 year warranty
- Sold each



Model P8P4AAD/SKU# .15157

Wall-Mounted Regulated Power Supply Center

- Designed to feed power to multi cameras at the same time from one central location
- Up to 8 ports and 4 amps total usage
- LED power indicator
- Metal cabinet with hinged door
- Optional A/C pigtail required
- 12V only
- 2 year warranty
- Sold each



Model P8P4AD/SKU# .10494

1X9 Power Distribution Box

- Distributes power to 9 different sources
- Supports up to 1-30VAC/VDC to 12V DC 1.1 Amps at 250VAC
- Surge protected and fused outlets
- LED indicators
- Sold each



Model P1X9AD12/SKU# .13815

AC to DC Power Converter

- Converts AC power to 12V/DC
- 14-24 V/AC to 12V/DC with DC plug
- 15V-30V/ DC to DC 12V (regulated)



Model PC12D24A1/SKU# .13814

Audio Pickup Microphone

- In-line audio pick-up for cameras that were not originally equipped with audio microphones
- High sensitivity
- Built-in 12V DC power regulator



Model APU/SKU# .9635

Power Supply

- 12V DC 1.7AMP power supply designed for use with DirectConnect® cameras



Model PS17A/SKU# .15400

AC to DC Power Converter

- Converts AC power to 12V/DC
- 12-24 V/AC to 12V/DC with DC plug
- 15-30V/DC to 12V DC (regulated)



Model PC12D24A/SKU# .13813

Pigtail Plug

- Converts hard-wire camera power to molded DC power connector
- Designed for use with all DirectConnect® cameras
- Male version



Model HDCPT/SKU# .15399

Pigtail Jack

- Converts hard-wire camera power to molded DC power connector
- Designed for use with all DirectConnect® cameras
- Female version



Model HDCPTJ/SKU# .19655

FIELD OF VIEW/FOCAL LENGTH OF A LENS

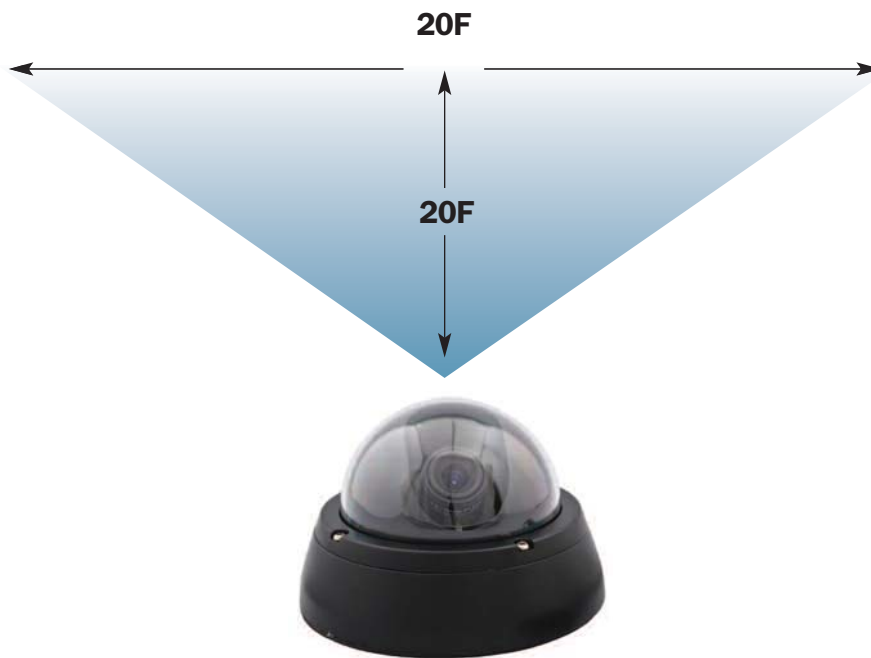

Field-of-View chart for 1/3" camera lens selections

Lens Size	DISTANCE FROM CAMERA									
	5'		10'		25'		50'		100'	
	Width	Height	Width	Height	Width	Height	Width	Height	Width	Height
2.8mm	8.5'	6.5'	17'	12.75'	43'	32'	86'	64.25'	171.5'	128.5'
3.5mm	7'	5'	13.75'	10.25'	34.25'	25.75'	68.5'	51.5'	137'	103'
4mm	6'	4.5'	12'	9'	30'	22.5'	60'	45'	120'	90'
6mm	4'	3'	8'	6'	20'	15'	40'	30'	80'	60'
8mm	3'	2.25'	6'	4.5'	15'	11.25'	30'	22.5'	60'	45'
12mm	2'	1.5'	4'	3'	10'	7.5'	20'	15'	40'	30'
16mm	1.5'	1.25'	3'	2.25'	1.5'	5.5'	15'	11.25'	30'	22.5'
25mm	11"	9"	1.75'	1.25'	4.75"	3.5"	9.5'	7.25'	19'	14.5'
50mm	6"	4"	11"	9"	2.25"	1.75"	4.75'	3.5'	9.5'	3.5'

Please note: Specifications are subject to change without notice

STRUCTURED PANELS

UL Structured Panels

- 18"/28" standard in-wall mounting panel
- Universal mounting system allows for use with DirectConnect® or other brands
- Hinged cover can be mounted on the left or the right side of the structured panel
- Eight (8) cable and one (1) electrical duplex knock-out
- SP18L and SP28L include latching lock and key
- SP48L includes traditional lock and key
- Color – white
- All panels share same stamp pattern, reversible hinged cover, and knock-out patterns
- UL rating for fire AND security



Model SP18L-UL/18"/SKU# .10687

Model SP28L-UL/28"/SKU# .10688

Model SP48/48"/SKU# .10207

SP18L Kit2

18" structured panel kit includes:

- 18" panel, 1X8 video splitter (SKU# .13392), and 1X8 voice w/RJ31X module (SKU# .10209)

Kit: SKU# .10515

SP28L Kit2

28" structured panel kit includes:

- 28" panel, 1X8 video splitter (SKU# .13392), and 1X8 voice w/RJ31X module (SKU# .10209)

Kit: SKU# .10549

Structured Panel Covers



Model SP18LC/18"/SKU# .11233

Model SP28LC/28"/SKU# .11227

Model SP48C/48"/SKU# .10411 (Shown)

Accessories

Model KEY1/SKU# .11178

Model LOCK48/SKU# .19897

8 X 8 Voice and Video Distribution Module/Combo Module

- 8 location voice module
- 8 way coax/video splitter
- RJ31 jack for security connection
- Pre-mounted on universal bracket and mounting plate for structured panel



MODEL 8X8VTRJ31X/SKU# .10748

3 X 8 Enhanced Video Module

- Allows three video feeds to be distributed to eight different locations
- Includes termination caps for unused ports
- Includes bracket to mount inside structured panel



Model 38EVM/SKU# .10086

1 X 10 Voice Module

- 1 in 10 out voice module
- In/out loop and 10 RJ45 outputs
- All connectors are parallel with each other
- With RJ31X for security
- Bracket included



Model V10RJ45/SKU# .10993

1 X 9 110 Bridged Voice Module

- 1 in 9 out voice module
- Expansion module
- Bracket included to be mounted in structured panel



Model BVM1X9/SKU# .9447

1 X 8 110 Bridged Voice Module

- 1 in 8 out voice module
- 1 RJ31 jack for security
- Bracket included for structured panel



Model BVM1X8RJ31X/SKU# .10209

1 X 8 Passive Video Splitter

- 1 in 8 out video splitter; splits and transmits one video source to four different display devices



Model USMVSP8W/SKU# .16198

1 X 8 Passive Video Splitter w/ Universal Mount

- Split one video coax signal to eight devices
- Comes on universal mounting bracket for structured panel



Model VSP8WU/SKU# .10503/SKU# .13392 (2GHTZ unit)

1 X 4 Passive Video Splitter

- 1 in 4 out video splitter; splits and transmits one video source to four different display devices
- Decorator style plate
- Includes trim plate



Model DVSP4W/SKU# .11836

1 X 4 110 Bridged Voice Module

- 1 in 4 out voice module punch down
- Decorator style plate
- Includes trim plate



Model DBVM1X4/SKU# .11835

Six-Way Speaker Hub

- Split one pair of speakers into six
- Non-impedance matching
- Terminal connections
- Bracket included



Model SP1X6/SKU# .10367

Video Engine Bi-Directional Amp

- Two-way drop amp with CATV and AUX inputs
- +15db gain
- Mounts in structured panel



Model VEBDA/SKU# .10087

STRUCTURED PANELS (CONTINUED)

Voice Data Module

- Eight (8) location voice/data module
- Patch into ethernet hub
- Easily switch phone extensions
- Mounts inside structured panel

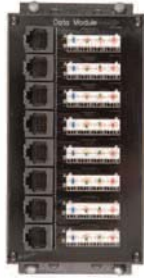

Model VD88R45/SKU# .10425

Universal Keystone Plate

- For UB1 and UB3 brackets
- Designed to mount keystone jacks or inserts into structured panel



Model UKP/SKU# .11487

Mounting Plates and Brackets

- Our mounting plates and brackets let you customize your panels. Configure either bracket with the mounting plate for a truly custom fit



Model UB1 Bracket/
SKU# .6906

- Use for smaller items such as routers
- Fits all DirectConnect® structured panels



Model UB3 Bracket/
SKU# .6907



Model UMP Plate/
SKU# .10191

Universal Wi-Fi Adaptor for Structured Panel

- Wi-Fi antenna mount for structured panel
- Extends the signal of the wireless router to the outside of the metal structured cabinet for improved Wi-Fi coverage

Model SPWIFIANT/SKU# .17256



Antenna not included

Universal Wi-Fi Antenna Extension Cable

- Wi-Fi antenna extension cable

Model SPWIFIANTEXT/SKU# .17736

Universal Structured Panel Bracket (Large)

- Allows the use of common accessories to be mounted in the structured panel
- Fits most structured panels
- Large: F/5 X 11.5" mounting



Model SPMUBRACKETLRG/SKU# .17258

Universal Structured Panel Bracket (Small)

- Allows the use of common accessories to be mounted in the structured panel
- Fits most structured panels
- Small: F/5 X 3.5" mounting



Model SPMUBRACKETSML/SKU# .17257

DSC Security Panel Mount Bracket for PC1616

- Mounts security board PC1616 inside the structured panel
- Module not included



Model USMDSC/SKU# .16199

Mounting Tap F/18" Distribution Panel



Model SP18MT/SKU# .13178

Universal Battery Panel Mount

- Designed to secure alarm battery into a structured panel



Model USMBM/SKU# .16200

Full Can Width Universal Bracket

- Full length universal bracket for customizing DirectConnect® structured panels
- Fits all panel sizes



Model UBFULL/SKU# .10980

Hinge Screws for SP18L/SP28L/SP48

- 100 pack



Model 1/2S-100/SKU# .11194

Latch

- Replacement latch for SP18L and SP28L cover



Model LATCH/SKU# .11336

48 Port CAT6 Patch Panel

- Panel works with HWB2 bracket (2RMU space)



Model C6PP48/SKU# .12896

Enhanced CAT5 Patch Panels

- Rated to 350 MHz
- T568B wiring
- Rack mountable



Model C5EPP24 (24 ports)/SKU# .7016



Model C5EPP48 (48 ports)/SKU# .1439

50 Pair Punch Block

- 25/PK

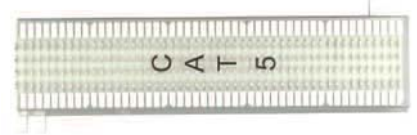

Model 66M150/SKU# .5506

24 Port CAT6 Patch Panel

- Works with HWB1 bracket (1RMU space)



Model C6PP24/SKU# .11102

CAT5e, 12Port Patch Panel

- Meets EIA/TIA 568-B UTP standards
- Includes S89D wall bracket
- Silkscreened area for easy documentation
- 30/PK



Model C5EPP12/SKU# .8120

50 Pair 110 Wiring Block

- 100/PK



Model 110WB50/SKU# .9449

12 Port CAT6 Patch Panel with Bracket

- 30/PK



Model C6PP12/SKU# .10148

Punch-Down Tool

- 8 x 110PD punch-down tool
- For use with CAT5 or CAT6 jacks



Model 110X8-2D/SKU# .11501

50 Pair 110 Wiring Block with Legs

- 100/PK

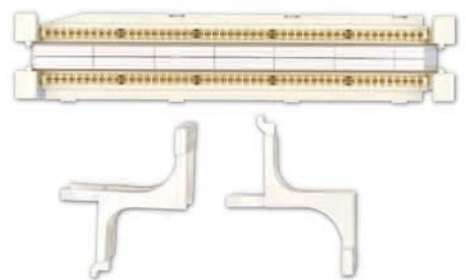

Model 110WB50WL/SKU# .9450

Hinged Wall Bracket

- Secures a patch panel to the wall for a neat professional installation
- 1RMU space hinged wall bracket designed to mount to a 24 port CAT5 or voice patch panel
- Black



Model	Rack Size	SKU#
HWB1	1 space	.6091
HWB2	2 space	.4824
HWB3	3 space	.6089
HWB4	4 space	.14789

Die for 8X110PD Punch-Down Tool

- Die only
- For use with the 8X110PD tool and Leviton® jacks



Model 110LEVD/SKU# .18188

Die for 8X110PD Punch-Down Tool

- Die only
- For use with the 8X110PD tool and DirectConnect® jacks



Model 110DCD/SKU# .18187

Telco Wall Bracket

- S89D mounting bracket for S66-M150 blocks
- 10/PK



Model TWB/SKU# .7098

Phone Extension Cable

- Extended length telephone cable



Model	Length	Type	Color	SKU#
LC7-SI	7ft	4 Cond	Silver	.1048
LC15-SI	15ft	4 Cond	Silver	.846
LC25-BK	25ft	4 Cond	Black	.861

Four-Pair Clip for 110C Wiring Block

- 10/PK



Model 110C-8/SKU# .9709

Telecom Distribution Wire Post

- Used to help manage Telco data wires on phone system punch down boards



Model DWP/SKU# .2395

Modular Outlet Box

- Connects up to 5 telephones or related equipment to an existing single modular jack
- 4 conductor
- Self-adhesive backing
- 20/PK



Model MS5W/SKU# .5254

Surface Modular Jacks



Model	Type	Pkg	Color	SKU#
SJ64-WH	4 Cond	30	White	.4983
SJ88K-WH	8 Cond	50	White	.6018 (keyed)

Modular Cord Couplers



Model	Type	Pkg	SKU#
LCC64	4 Cond	100	.2808
LCC66	6 Cond	100	.6026
LCC88K	8 Cond	100	.6029 (Keyed)
LCC88K-D	8 Cond	100	.15112 (Data)

Dual Modular Adaptors

- Allows any two devices to be connected to a singular modular jack



Model	Type	Pkg	SKU#
T64	4 Cond	25	.2811
T66	6 Cond	30	.2156

Keystone CAT5e Coupler

- 100/PK



Model KC5EF/SKU# .7599 (Black)
SKU# .13496 (White)

RJ45F to 2XRJ11F Duplex Adaptor



Model # RJ45M2RJ11F/SKU# .11553

Modular Plugs

For twisted pair stranded, round cable
100/Pk.

Model	Type	Cond	SKU#
PT064R	RJ11	6P4C	.6020
PT066R	RJ12	6P6C	.6023
PT088R	RJ45	8P8C	.6025

For stranded flat cable

Model	Type	Cond	SKU#
PT044	RJ22	4P4C (Handset plug)	.1288
PT064	RJ11	6P4C	.1286

For twisted pair solid, round cable stranded flat cable

Model	Type	Cond	SKU#
PT064RS	RJ11	6P4C	.4786
PT066RS	RJ12	6P6C	.4791
PT088RS	RJ45	8P8C	.1052
PT088C5UL	(RJ45)CAT5	8P8C	.5998
PT088RS6S	(RJ45)CAT6	8P8C	.19001
PT088S	CAT5	8P8C	.3852



Tech Note

Color codes for RJ-45 ethernet plug

Eight-conductor data cable contains 4 pairs of wires. Each pair consists of a solid color wire and color striped wire. Each of the pairs are twisted together to maintain reliability on Ethernet. You should not untwist them any more than necessary (about 1/4 inch).

There are two wiring standards for these cables, called T-568A and T-568B. They differ only in pin assignments, not in uses of the various colors. Specifications for T-568B assign orange and green pairs on pins 1,2 and 3,6. T-568A specification reverses the orange and green connections, so blue and orange pairs are on the center 4 pins, which has compatibility with telco voice connections.

Pin number designations

T-568B

Pin	Color	Pair	Description
1	white/orange	2	TxData+
2	orange	2	TxData-
3	white/green	3	RecvData+
4	blue	1	Unused
5	white/blue	1	Unused
6	green	3	RecvData-
7	white/brown	4	Unused
8	brown	4	Unused

T-568A

Pin	Color	Pair	Description
1	white/green	3	RecvData+
2	green	3	RecvData-
3	white/orange	2	TxData+
4	blue	1	Unused
5	white/blue	1	Unused
6	orange	2	TxData-
7	white/brown	4	Unused
8	brown	4	Unused

Note: Odd pin numbers are always the striped wires.

INTERCONNECTS

HQRV Composite Video Cables

- Bulk packaging
- High quality video transmission
- Gold plated connections
- 99.9% OFC
- Low capacitance cable



Bulk Package		
Model	Length	SKU#
HQRV-.5MB	.5M	.12450
HQRV-1MB	1M	.7202
HQRV-2MB	2M	.7203
HQRV-3MB	3M	.7204
HQRV-5MB	5M	.7206

HQRSA Audio Cables

- Bulk packaging
- High quality audio transmission
- Gold plated connections
- 99.9% OFC
- Low capacitance cable



Bulk Package		
Model	Length	SKU#
HQRSA-.5MB	.5M	.12449
HQRSA-1MB	1M	.7207
HQRSA-2MB	2M	.7208
HQRSA-3MB	3M	.7209
HQRSA-5MB	5M	.7210
HQRSA-8MB	8M	.10984
HQRSA-S200	200' spool	.2005

HQDC Digital Coax Cables

- High quality media transmission
- Gold plated connections



Bulk Package		
Model	Length	SKU#
HQDC-.5MB	.5M	.12445
HQDC-1MB	1M	.8497
HQDC-2MB	2M	.8498
HQDC-3MB	3M	.8499
HQDC-5MB	5M	.8500
HQDC-8MB	8M	.11008

HQSUB Subwoofer Cables

- Heavy duty size for better sub performance
- Gold plated connections



Bulk Package		
Model	Length	SKU#
HQSUB-.5MB	.5M	.12451
HQSUB-1MB	1M	.8538
HQSUB-2MB	2M	.8539
HQSUB-3MB	3M	.8540
HQSUB-5MB	5M	.8541
HQSUB-8MB	8M	.8542
HQSUB-15MB	15M	.8544
HQSUB-30MB	30M	.8543

HQCC Component Cables

- Bulk packaging
- High definition TV component cable
- Gold plated connections
- 99.9% OFC
- Low capacitance cable



Bulk Package		
Model	Length	SKU#
HQCC-.5MB	.5M	.12337
HQCC-1MB	1M	.6280
HQCC-2MB	2M	.6282
HQCC-3MB	3M	.6284
HQCC-5MB	5M	.6286
HQCC-8MB	8M	.4037
HQCC-15MB	15M	.7597

HQFO Fiber Optic Cables

- Bulk packaging
- High quality audio transmission
- Protective dust cap



Bulk Package		
Model	Length	SKU#
HQFO-.5MB	.5M	.12447
HQFO-1MB	1M	.5789
HQFO-2MB	2M	.5792
HQFO-3MB	3M	.5795
HQFO-5MB	5M	.5798
HQFO-8MB	8M	.11006

High-Quality Audio Video Dubbing Cables

- Our best audio and video dubbing cables
- Shielded; color-coded metal connectors
- Gold-plated tips for better performance



Model	Length	SKU#
HQDUB-0.5M	.5M	.12446
HQDUB-1M	1M	.7194
HQDUB-2M	2M	.7195
HQDUB-3M	3M	.7196
HQDUB-5M	5M	.7197
HQDUB-8M	8M	.11007

HQSVHS S-VHS Video Cables

- Bulk packaging
- High quality video transmission
- Gold plated connections
- 99.9% OFC
- Low capacitance cable



Bulk Package		
Model	Length	SKU#
HQSVHS-.5MB	.5M	.12452
HQSVHS-1MB	1M	.7198
HQSVHS-2MB	2M	.7199
HQSVHS-3MB	3M	.7200
HQSVHS-5MB	5M	.7201
HQSVHS-8MB	8M	.2036
HQSVHS-15MB	15M	.2025
HQSVHS-30MB	30M	.2031

INTERCONNECTS (CONTINUED)

Category 6 Patch Cables

Model	Length	Color	SKU#
CAT6-WH-3	3'	White	.11340
CAT6-WH-5	5'	White	.11341
CAT6-WH-7	7'	White	.11342
CAT6-WH-10	10'	White	.11343
CAT6-WH-14	14'	White	.11345
CAT6-WH-25	25'	White	.11344

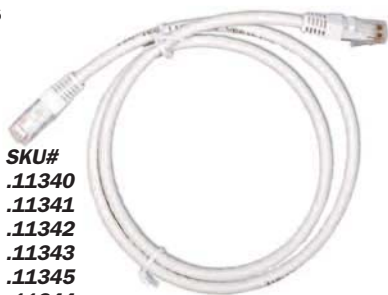

High-Quality VGA to Component Video Cables

- 15HD male to 3 RCA male outputs (component)
- Gold plated

Model	Length	SKU#
HQSVGACC3B	3'	.7864
HQSVGACC6B	6'	.6036
HQSVGACC12B	12'	.7900
HQSVGACC25B	25'	.7865



Category 5e Patch Cables

Model	Length	Color	SKU#
CAT5E-1	1'	Black	.7456
		Gray	.10619
		Yellow	.11960
CAT5E-3	3'	Blue	.4093
		Gray	.9649
		White	.8659
		Yellow	.8660
CAT5E-5	5'	Blue	.4097
		White	.8664
		Yellow	.20213
CAT5E-7	7'	Blue	.4100
		White	.8670
		Yellow	.8669
CAT5E-10	10'	Blue	.4102
		White	.9555
		Yellow	.10753
CAT5E-14	14'	Blue	.4104
		White	.9379
		Yellow	.20450
CAT5E-25	25'	Blue	.20212
		White	.9406
		Yellow	.20211



SKU# .9649

SKU# .4093

High-Quality RGB Cables

- True 75 ohm cables
- High Performance
- Gold plated

Model	Length	SKU#
HQRGB6B	6'	.7499
HQRGB12B	12'	.7498
HQRGB25B	25'	.3468
HQRGB50B	50'	.3741
HQRGB100B	100'	.6537
HQRGB-H250B	250'	.9392



Premium Audio Video Dubbing Cables

- Premium quality audio and video dubbing cables
- Shielded; color-coded molded connectors
- Gold-plated tips for better performance

Model	Length	SKU#
DUB3B	3'	.6550
DUB6B	6'	.2924
DUB12B	12'	.2936
DUB25B	25'	.5784



High-Quality Male to Male SVGA/XVGA Cables

Model	Type	Length	SKU#
HQSVGA15MM6B	SVGA	6'	.978
HQSVGA15MM12B	SVGA	12'	.975
HQSVGA15MM25B	SVGA	25'	.977
HQSVGA15MM50B	SVGA	50'	.1461
HQSVGA15MM100B	SVGA	100'	.5599



High-Quality SVGA to 5BNC Cables

- 15HD male to 5 BNC
- Gold plated

Model	Type	Length	SKU#
HQSVGA15M5BNCF1B	SVGA/5 BNC F	1'	.7813
HQSVGAM5BNC6B	SVGA/5 BNC M	6'	.4878
HQVGM5BNC25B	SVGA/5 BNC M	25'	.983
HQVGM5BNC50B	SVGA/5 BNC M	50'	.5800



Standard Stereo Audio Patch Cables

- Dual RCA plugs; 20AWG stranded copper cable
- Shielded; color-coded molded connectors
- Gold-plated tips for better performance

Model	Length	SKU#
ST3B	3'	.19196
ST6B	6'	.19197
ST12B	12'	.19194
ST25B	25'	.19525
ST50B	50'	.86

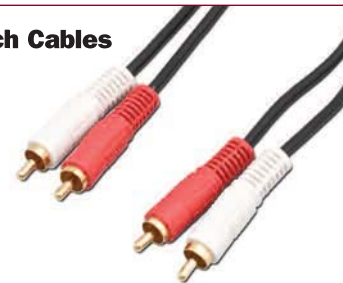

INTERCONNECTS (CONTINUED)

High-Quality HDMI™ High Speed with Ethernet Interconnect Cables

- CL3 Rated
- Up to 1080P at 340 MHz
30-36 Bit color
- 1920x1200 Computer resolution
- 1440P/2k Graphics



Model	Length	SKU#
HQDMIE-A-0.5MB	.5M	.21297
HQDMIE-A-1MB	1M	.21300
HQDMIE-A-2MB	2M	.21301
HQDMIE-A-3MB	3M	.21302
HQDMIE-A-5MB	5M	.21303
HQDMIE-A-7.5MB	7.5M	.21304
HQDMIE-A-10MB	10M	.21298
HQDMIE-A-15MB	15M	.21299

High-Quality HDMI™ High Speed Interconnect Cables

- Up to 1080P
- 165 MHz
- 8 Bit color



Model	Length	SKU#
HQDMI-A-.5MB	.5M	.12448
HQDMI-A-1MB	1M	.11106
HQDMI-A-2MB	2M	.11107
HQDMI-A-3MB	3M	.11108
HQDMI-A-5MB	5M	.11109
HQDMI-A-7.5MB	7.5M	.11110
HQDMI-A-10MB	10M	.12761
HQDMI-A-15MB	15M	.12762

High-Quality HDMI™ High Speed with Ethernet Flat Interconnect Cables

- CL3 Rated
- Up to 1080P at 340 MHz
30-36 Bit color
- 1920x1200 Computer resolution
- 1440P/2k Graphics

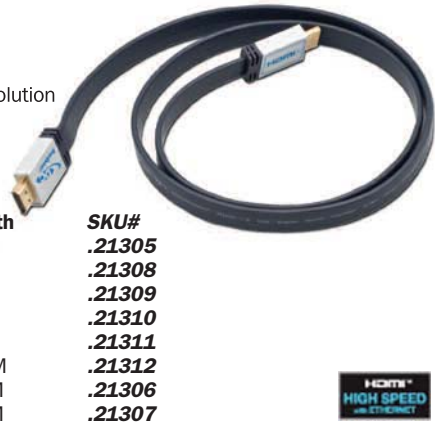

Model	Length	SKU#
HQDMIEF-A-0.5MB	.5M	.21305
HQDMIEF-A-1MB	1M	.21308
HQDMIEF-A-2MB	2M	.21309
HQDMIEF-A-3MB	3M	.21310
HQDMIEF-A-5MB	5M	.21311
HQDMIEF-A-7.5MB	7.5M	.21312
HQDMIEF-A-10MB	10M	.21306
HQDMIEF-A-15MB	15M	.21307

Economy HDMI™ High Speed Interconnect Cables

- Up to 1080P
- 165 MHz
- 8 Bit color



Model	Length	SKU#
HDMI-0.5M	0.5'	.19183
HDMI-3M	3'	.18282
HDMI-6M	6'	.18283
HDMI-10M	10'	.18284
HDMI-15M	15'	.18285
HDMI-20M	20'	.18286
HDMI-30M	30'	.18287

High-Quality HDMI™ High Speed Interconnect Cables

- CL3 Rated
- Up to 1080P at 340 MHz
30-36 Bit color
- 1920x1200 Computer resolution
- 1440P/2k Graphics



Model	Length	SKU#
HQDMI-M-A-1MB	1M	.18125
HQDMI-M-A-2MB	2M	.18126
HQDMI-M-A-3MB	3M	.18127
HQDMI-M-A-5MB	5M	.18128
HQDMI-M-A-10MB	10M	.18129
HQDMI-M-A-15MB	15M	.18130
HQDMI-M-A-20MB	20M	.18131

High-Quality RCA Y-Adaptor Cables

- Our best RCA Y-adaptors in assorted styles
- Metal-ends; gold-plated tips for better performance



Model	Style	Length	SKU#
HQY1M2F	1 RCA Male to 2 RCA Female	1'	.9298
HQY1F2M	1 RCA Female to 2 RCA Male	1'	.9297

High-Quality HDMI™ Flat High Speed Interconnect Cables

- Up to 1080P
- 165 MHz
- 8 Bit color



Model	Length	SKU#
HQDMI-F-A-1MB	1M	.15135
HQDMI-F-A-2MB	2M	.15136
HQDMI-F-A-3MB	3M	.15137
HQDMI-F-A-5MB	5M	.15138
HQDMI-F-A-7.5MB	7.5M	.15139
HQDMI-F-A-10MB	10M	.15140
HQDMI-F-A-15MB	15M	.15141

Premium RCA Y-Adaptor Cables

- Premium RCA Y-adaptors in assorted styles
- Metal-ends; gold-plated tips for better performance



Model	Style	Length	SKU#
STY1FB	2 RCA Male to 1 RCA Female	1'	.6039
STY2FB	1 RCA Male to 2 RCA Female	1'	.6538
STY3MB	1 RCA Male to 2 RCA Male	1'	.65

INTERCONNECTS (CONTINUED)

Standard RCA Y-Adaptor Cables

- 2 RCA Male to 1 RCA Female
- Molded connectors



Model	Style	Length	SKU#
STY1FB	2 RCA Male to 1 RCA Female	1'	.19526

Standard S-VHS to RCA Y-Adaptor

Color-coded; molded connectors



Model	Style	Length	SKU#
SVM2RMB	1 SVHS Male to 2 RCA Male	6"	.3999

3.5MM Male Stereo to 2 RCA Female Y-Adaptor

- Color-coded; molded connectors



Model	Style	Length	SKU#
ST2RF35M	3.5MM Stereo Male to 2 RCA Female	1'	.19195

Standard S-VHS to BNC Y-Adaptor Cables

- Assorted styles
- Molded connectors



Model	Style	Length	SKU#
SVM2BFB	1 SVHS Male to 2 BNC Female	1'	.4002
SVM2BMB	1 SVHS Male to 2 BNC Male	1'	.4000

3.5MM Male Stereo to 2 RCA Male Y-Adaptor

- Color-coded; molded connectors



Model	Style	Length	SKU#
35MMST2RM-6	3.5MM Stereo Male to 2 RCA Male	6"	.19527

Stereo Audio Piggyback

- Color-coded; molded connectors



Model	Style	Length	SKU#
ST6PB	6' Stereo Audio Piggyback	6'	.553

DPL raises the bar for HDMI products

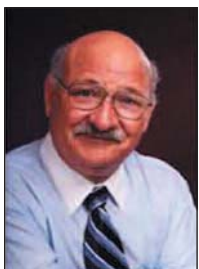

Jeffrey Boccaccio
DPL Labs Founder and President

The DPL (Digital Performance Level) program brings an entirely new method for HDTV dealers, installers and customers to measure the actual performance of critical high-speed digital products.

Now, for the first time, an easy measurement standard has been developed to judge and purchase these types of products strictly by how well they perform over and above the HDMI minimum standard, rather than depending on who has fancier packaging or who makes the highest (unfounded) claims, which has been the norm in the past. Each aspect of the HDMI interface is measured and mathematically computed to offer the user an easy-to-understand performance-scoring tool.

A simple 1 to 5 scoring system is all it takes to determine what HDMI product to purchase. The entry score of 1 tells the buyer that the product does in fact pass the minimum standards required by HDMI. As the score increases, so does the integrity of the product. The highest possible DPL score is 5.

The consistency of the product is determined by sampling five random products for test. The products are periodically re-purchased through time in an effort to guarantee that the same performance level is maintained in the marketplace.

More and more firms are realizing the importance of this program and are throwing their hat in the ring to prove how their products perform, compared with others in the program.

DirectConnect, as one of the first participants in the DPL program and like all members companies, recognizes the importance of a standardized rating system to ensure a level playing field

and provide assurance for end users and installers that the cable they purchase meets significant standards. **DirectConnect** is the first company to receive a "5" rating on a tested cable (HDMI-A-0.5MB), which is the highest quality rating available from DPL Labs and denotes the superior performance of this cable.

More information on the program is available at www.dplrating.org.

The Stratecon Group
Strategic Concepts in Marketing



DirectConnect is a member of the DPL program

INTERCONNECTS (CONTINUED)

SVGA Y-Adaptor

- Heavy-duty molded connectors



Model	Style	Length	SKU#
HD15MY2HD15F	SVGA Y HD 15DB Male to 2 HD15 Female	6'	.6971

Premium S-VHS Dubbing Cables

- Premium quality S-Video with stereo audio cable
- Shielded; color-coded molded connectors
- Gold-plated tips for better performance



Model	Length	SKU#
SVHS-6B	6'	.2884
SVHS-12B	12'	.2886
SVHS-25B	25'	.5850
SVHS-50B	50'	.5852
SVHS-100B	100'	.5904

Standard S-VHS to S-VHS Y-Adaptor Cables

- Assorted styles
- Molded connectors



Model	Style	Length	SKU#
SVY1FB	1 SVHS Female to 2 SVHS Male	1'	.3995

Standard S-VHS Dubbing Cables

- S-Video with stereo audio cable
- Shielded; color-coded molded connectors
- Gold-plated tips for better performance



Model	Length	SKU#
SVDUB-3B	3'	.1251
SVDUB-6B	6'	.1255
SVDUB-50B	50'	.1264

3.5MM to 3.5MM Stereo Male to Female Cable

- 3.5MM stereo male to female extension cable
- Shielded; molded connectors



Model	Length	SKU#
35F35M-50ST	50'	.4459

3.5MM to 3.5MM Stereo Male to Male Cable

- 3.5MM stereo male to male cable
- Shielded; Molded connectors



Model	Length	SKU#
35M35M-6ST	6'	.5540
35M35M-12ST	12'	.267
35M35M-25ST	25'	.10197

3.5MM to 3.5MM Mono Male to Female Cable

- 3.5MM mono male to female extension cable
- Shielded; molded connectors



Model	Length	SKU#
35F35M10	10'	.7280

3.5MM to 3.5MM Mono Male to Male Cable

- 3.5MM mono male to male cable
- Shielded; molded connectors



Model	Length	SKU#
35M35M-1	1'	.371
35M35M-5	5'	.136
35M35M-10	10'	.376

WIRE

Speaker Wire

- 2 Conductor
- Sequential foot markers
- UL and riser rated
- PVC



162-GN-B1K shown

Model	Gauge/Strand	Conductors	Color	Put up	SKU#
162-GN-B1K	16/26	2	Green	1K Box	.2574
162-GN-B500	16/26	2	Green	500' Box	.7379
162-GY-B1K	16/26	2	Gray	1K Box	.1769
162-GY-B500	16/26	2	Gray	500' Box	.7818
162-GY-S1K	16/26	2	Gray	1K Spool	.11767
162-PUR-B1K	16/26	2	Purple	1K Box	.9181
162-WH-B1K	16/26	2	White	1K Box	.1354
162-WH-B500	16/26	2	White	500' Box	.1360
162-WH-R1K	16/26	2	White	1K Reel In Box	.11535
162-WH-S1K	16/26	2	White	1K Spool	.1485
162-YL-B1K	16/26	2	Yellow	1K Box	.10800
182-WH-B1K	18/16	2	White	1K Box	.3710

Speaker Wire

- 4 Conductor
- Sequential foot markers
- UL and riser rated
- PVC

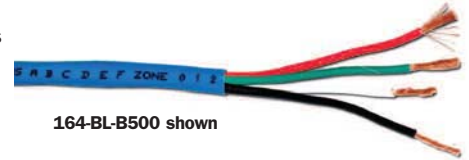

164-BL-B500 shown

Model	Gauge/Strand	Conductors	Color	Put up	SKU#
164-BL-B500	16/26	4	Blue	500' Box	.2664
164-BL-S1K	16/26	4	Blue	1K Spool	.4108
164-GN-B500	16/26	4	Green	500' Box	.7783
164-GY-B500	16/26	4	Gray	500' Box	.3527
164-GY-S1K	16/26	4	Gray	1K Spool	.1380
164-OR-B500	16/26	4	Orange	500' Box	.4893
164-WH-B500	16/26	4	White	500' Box	.2661
164-WH-R500	16/26	4	White	500' Reel In Box	.11537
164-WH-S1K	16/26	4	White	1K Spool	.1486
164-YL-B500	16/26	4	Yellow	500' Box	.10801
184-WH-B500	18/16	4	White	500' Box	.3708

HD Speaker Wire

- 2 Conductor
- Sequential foot markers
- UL and riser rated
- PVC



122HD-BU-B1K shown

Model	Gauge/Strand	Conductors	Color	Put up	SKU#
122HD-BU-S1K	12/65	2	Burgundy	1K Spool	.4815
142HD-WH-S1K	14/41	2	White	1K Spool	.803
162HD-BL-B500	16/65	2	Blue	500' Box	.5597
162HD-GN-B500	16/65	2	Green	500' Box	.12939
162HD-PU-B500	16/65	2	Purple	500' Box	.15166
162HD-WH-B1K	16/65	2	White	1K Box	.2099
162HD-WH-B500	16/65	2	White	500' Box	.2101
162HD-WH-S1K	16/65	2	White	1K Spool	.4835
162HD-YL-B500	16/65	2	Yellow	500' Box	.1376

HD Speaker Wire

- 4 Conductor
- Sequential foot markers
- UL and riser rated
- PVC

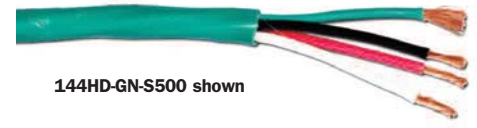

144HD-GN-S500 shown

Model	Gauge/Strand	Conductors	Color	Put up	SKU#
124HD-BU-S500	12/65	4	Burgundy	500' Spool	.6388
144HD-BU-S1K	14/41	4	Burgundy	1K Spool	.4825
144HD-BU-S500	14/41	4	Burgundy	500' Spool	.5394
144HD-GN-S500	14/41	4	Green	500' Spool	.8003
144HD-WH-S500	14/41	4	White	500' Spool	.7928
164HD-GN-B500	16/65	4	Green	500' Box	.5185
164HD-VL-B500	16/65	4	Violet	500' Box	.282
164HD-VL-S1K	16/65	4	Violet	1K Spool	.5328
164HD-WH-B500	16/65	4	White	500' Box	.1567
164HD-WH-S1K	16/65	4	White	1K Spool	.5325

Plenum Speaker Wire

- 2 Conductor
- Sequential foot markers
- UL CMP rated



P142-WH-S1K shown

Model	Gauge/Strand	Conductors	Color	Put up	SKU#
P142-WH-S1K	14/19	2	White	1K Spool	.4741
P162-WH-B1K	16/19	2	White	1K Box	.42
P182-WH-B1K	18/7	2	White	1K Box	.6373

Plenum Speaker Wire

- 4 Conductor
- Sequential foot markers
- UL CMP rated



Model	Gauge/Strand	Conductors	Color	Put up	SKU#
P164-WH-S1K	16/19	4	White	1K Spool	.6733

Shielded Speaker Wire

- 2 Conductor
- Sequential foot markers
- UL and riser rated
- PVC



Model	Gauge/Strand	Conductors	Color	Put up	SKU#
182S-GY-B1K	18/16	2	Gray	1K Box	.4839

Shielded Speaker Wire

- 4 Conductor
- Sequential foot markers
- UL and riser rated
- PVC



Model	Gauge/Strand	Conductors	Color	Put up	SKU#
184S-GY-S1K	18/16	4	Gray	1K Spool	.4846
224S-GY-B1K	22/7	4	Gray	1K Box	.5482

Burial Speaker Wire

- 2 Conductor
- Sequential foot markers
- PVC jacket sunlight resistant



162B-BK-S1K shown

Model	Gauge/Strand	Conductors	Color	Put up	SKU#
142B-BK-S500	14/19	2	Black	500' Spool	.5212
162B-BK-S1K	16/19	2	Black	1K Spool	.4025

Burial Speaker Wire

- 4 Conductor
- Sequential foot markers
- PVC jacket sunlight resistant

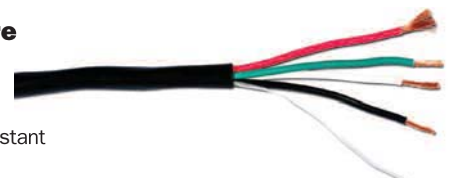

Model	Gauge/Strand	Conductors	Color	Put up	SKU#
164B-BK-S1K	16/19	4	Black	1K Spool	.3205

Security Wire

- 2 Conductor
- Sequential foot markers
- UL and riser rated
- PVC
- Stranded

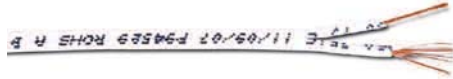

222 ZIP-WH shown

Model	Gauge	Conductors	Color	Put up	SKU#
222-ZIP-WH-B1K	22	2	White	1K Box	.7691
222-WH-B1K	22	2	White	1K Box	.7692
222-WH-P500	22	2	White	500' Bag	.9476
222-YL-P500	22	2	Yellow	500' Bag	.8049
222-BL-P500	22	2	Blue	500' Bag	.13338
222-GN-P500	22	2	Green	500' Bag	.15283
222-BR-P500	22	2	Brown	500' Bag	.18473
222-GY-P500	22	2	Gray	500' Bag	.18474

Security Wire

- 4 Conductor
- Sequential foot markers
- UL and riser rated
- PVC

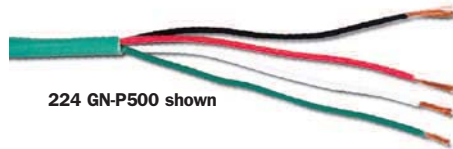

224 GN-P500 shown

Model	Gauge	Conductors	Color	Put up	SKU#
Stranded					
224 GN-P500	22	4	Green	500' Bag	.13339
224 OR-P500	22	4	Orange	500' Bag	.13342
224 WH-B1K	22	4	White	1K Box	.7694
224 WH-P500	22	4	White	500' Bag	.8150
Solid					
224A-BL-P500	22	4	Blue	500' Bag	.14105
224A-GN-P500	22	4	Green	500' Bag	.14099
224A-OR-P500	22	4	Orange	500' Bag	.14098
224A-WH-P500	22	4	White	500' Bag	.9268
224A-WH-B1K	22	4	White	1K Box	.7690
224A-YL-B1K	22	4	Yellow	1K Box	.9230
224A-YL-P500	22	4	Yellow	500' Bag	.14106

Solid Fire Alarm Wire

- 2 Conductor
- Meets code for fire alarm and monitor
- Riser rated FPLR
- Red PVC jacket solid
- UL rated



182PFPL-RD-B500 shown

Model	Gauge	Conductors	Color	Put up	SKU#
182PFPL-RD-B500	18	2	Red	500' Box	.6285
182PFPL-RD-P500	18	2	Red	500' Bag	.9475
182PFPL-RD-S500	18	2	Red	500' Spool	.4843

Solid Fire Alarm Wire

- 4 Conductor
- Meets code for fire alarm and monitor
- Riser rated FPLR
- Red PVC jacket solid
- UL rated

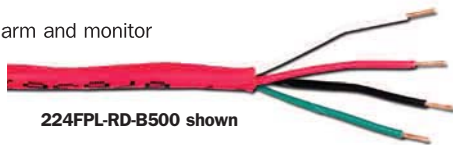

224FPL-RD-B500 shown

Model	Gauge	Conductors	Color	Put up	SKU#
184FPL-RD-B500	18	4	Red	500' Box	.2118
184FPL-RD-S1K	18	4	Red	1K Spool	.7214
224FPL-RD-B1K	22	4	Red	1K Box	.6333
224FPL-RD-B500	22	4	Red	500' Box	.2119
224FPL-RD-P500	22	4	Red	500' Bag	.9473

Performance Bundled Wire

- 14/4 or 16/4 Conductor with CAT5e
- 99.9% OFC
- CL3 rated
- 030° PVC jacket
- CMG rated
- UL/riser rated
- Foot markers

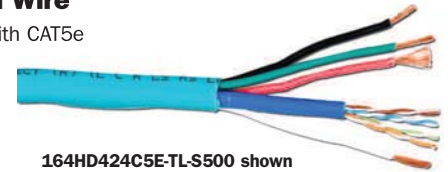

164HD424C5E-TL-S500 shown

Model	Combination bundled with	Color	Put up	SKU#
144HD424C5E-PU-S500	14g/4c with CAT5e	Purple	500' Spool	.11089
164HD424C5E-TL-S500	16g/4c with CAT5e	Teal	500' Spool	.7680

Structured Multi-Media Bundles

- Bundled RG6 Quad Coax and 2 CAT5E or CAT6
- UL rated • CAT5E rated 400MHz
- CAT6 rated 550MHz
- Fiber rated at 62.5 MHz



RG6Q2C5 shown

Model	Combination bundled with	Color	Put up	SKU#
RG6Q2C5E-BK-S500	1RG6Q with 2CAT5E (No Fiber)	Black	500' Spool	.13063
2RG6QCCS2C5EJ-BL-S500	2RG6Q with 2CAT5E (Fiber Included)	Blue	500' Spool	.1431
2RG6Q2C52FJ-PU-S500	2RG6Q with 2CAT5E (Fiber Included)	Purple	500' Spool	.1983
2RG6Q2C6-YL-S500	2RG6Q with 2CAT6 (Fiber Included)	Yellow	500' Spool	.10626

Bundled RGB Coax

- 5 RG59 cables with unterminated ends
- 20g solid copper with 95% solid copper braid
- UL/CM rated



Model	Combination bundled with	Color	Put up	SKU#
HQRGB-H250B	5 RG59 cables with unterminated ends	Black	250' Spool	.9392

Mini-Coax Cable

- 5 mini coax RGB with 1 CAT5E
- 23g
- UL rated



Model	Combination bundled with	Color	Put up	SKU#
HQRGB2C5E-H250B	5 mini coax RGB and 1 CAT5E bulk	Black	250' Spool	.11434

Bundled RGB Mini-Coax

- 5 mini coax RGB with 2 CAT5E
- 23g
- UL rated

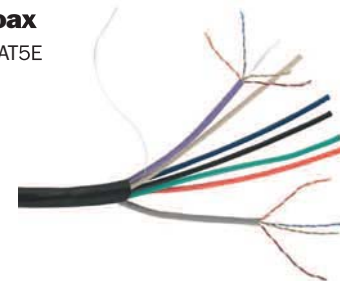

Model	Combination bundled with	Color	Put up	SKU#
HQRGB2C5E-H250B	5 mini coax RGB and 2 CAT5E bulk	Black	250' Spool	.15144

WIRE (CONTINUED)

Camera Wire

- Bundled RG59 with 18/2 power
- UL rated



RG59182-BK-S1K shown

Model	Combination bundled with	Color	Put up	SKU#
RG59182-BK-S1K	RG59 with 18g/2c	Black	1K Spool	.7392
RG59182-BK-S500	RG59 with 18g/2c	Black	500' Spool	.4129
With CAT5E				
RG59182C5E-BL-S500	RG59 with 18g/2c	Blue	500' Spool	.7730

Siamese Coax

- RG6 60% dual-shield siamese
- Solid copper
- UL rated



SRG63-BK-S1K shown

Model	Color	Put up	SKU#
SRG63-BK-S1K	Black	1K Spool	.3490
SRG63-BK-S500	Black	500' Spool	.10026

Plenum Coax Cable

- CMP rated
- CCS = Copper Clad Steel
- UL rated



Model	Color	Put up	SKU#
PRG6QCCS-WH-S1K	White	1K Spool	.14996

Coax Cable

- CM rated
- Multiple colors
- SC = Solid Copper
- PVC jacket
- Available in spools or boxes
- CCS = Copper Clad Steel

Model	Foil/Braid GHz	Center	% Shield	Color	Put up	SKU#
RG63-BK-B1K	1/1 Standard/3GHz	SC	60	Black	1K Box	.2346
RG63-WH-B1K	1/1 Standard/3GHz	SC	60	White	1K Box	.4686
RG63-WH-S1K	1/1 Standard/3GHz	SC	60	White	1K Spool	.880
RG63CCS-BK-S1K	1/1 Standard/3GHz	CCS	60	Black	1K Spool	.12241
RG63CCS-BK-B1K	1/1 Standard/3GHz	CCS	60	Black	1K Box	.12240
RG63CCS-WH-B1K	1/1 Standard/3GHz	CCS	60	White	1K Box	.12242
RG6Q3-BK-R1K	2/2 Quad/3GHz	SC	60/40	Black	1K RIB	.7237
RG6Q3-BK-S1K	2/2 Quad/3GHz	SC	60/40	Black	1K Spool	.3070
RG6Q3-RD-S1K	2/2 Quad/3GHz	SC	60/40	Red	1K Spool	.7994
RG6Q3-WH-S1K	2/2 Quad/3GHz	SC	60/40	White	1K Spool	.3072
RG6Q3-WH-R1K	2/2 Quad/3GHz	SC	60/40	White	1K RIB	.7238
RG6Q3-YL-S1K	2/2 Quad/3GHz	SC	60/40	Yellow	1K Spool	.7239
RG6Q3CCS-BK-B500	2/2 Quad/3GHz	CCS	60/40	Black	500' Box	.16263
RG6Q3CCS-BK-S1K	2/2 Quad/3GHz	CCS	60/40	Black	1K Spool	.12245
RG6Q3CCS-BK-B1K	2/2 Quad/3GHz	CCS	60/40	Black	1K Box	.12244
RG6Q3CCS-WH-S1K	2/2 Quad/3GHz	CCS	60/40	White	1K Spool	.12247
RG6Q3CCS-WH-B1K	2/2 Quad/3GHz	CCS	60/40	White	1K Box	.12246
RG6Q3CCS-WH-B500	2/2 Quad/3GHz	CCS	60/40	White	500' Box	.16264

Siamese

SRG63-BK-S500	1+1/1+1 Siamese/3GHz	SC	60	Black	500' Spool	.10026
SRG6Q3-BK-S500	2+2/2+2 Siamese/3GHz	SC	60/40	Black	500' Spool	.3073
SRG6Q3-BK-S1K	2+2/2+2 Siamese/3GHz	SC	60/40	Black	1K Spool	.18280
SRG6Q3-WH-S500	2+2/2+2 Siamese/3GHz	SC	60/40	White	500' Spool	.3685

Digital Coax

RG695D-BK-S1K	Digital 1/1 Standard/3GHz	SC	95	Black	1K Spool	.8764
---------------	---------------------------	----	----	-------	----------	-------

Aerial Cable

- CM rated
- Guy wire 18 gauge
- 3.0G CCS (Copper Clad Steel)
- CMP rated
- UL rated



Model	Color	Put up	SKU#
RG6Q3ACCS-BK-S1K	Black	1K Spool	.8459

Burial Cable

- PVC jacket
- 3.0G CCS (Copper Clad Steel)



Model	Color	Put up	SKU#
RG6QBCCS-BK-S1K	Black	1K Spool	.12575

Copper Braided Cable

- UL/CM rated
- PVC jacket
- 20 gauge solid copper conductor
- 95% copper braided wire
- RIB = Reel in a box



RG5995-BL-R250 shown

Model	Color	Put up	SKU#
RG5995-BK-B1K	Black	1K Box	.12897
RG5995-BK-S1K	Black	1K Spool	.12469
RG5995-BK-R250	Black	250' RIB	.10533
RG5995-BL-R250	Blue	250' RIB	.10528
RG5995-GN-R250	Green	250' RIB	.10530
RG5995-RD-R250	Red	250' RIB	.10529
RG5995-WH-R250	White	250' RIB	.10532
RG5995-YL-R250	Yellow	250' RIB	.10531



RG6Q3-BK-S1K shown



RG695D-BK-S1K Digital shown



RG6Q3CCS-BK-B500 shown

Category 5E Stranded PVC

- 24 gauge
- UL rated

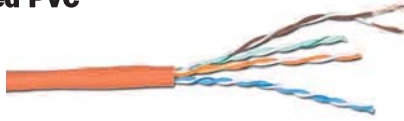

Model	Pairs	Type	Color	Put up	SKU#
424SC5E-S1K	4	Stranded	Orange	1K Spool	.14347

Category 6 PVC Cable

- 23 gauge
- UL rated
- 550Mhz

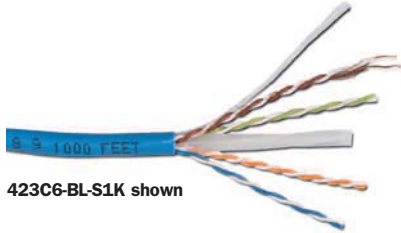

423C6-BL-S1K shown

Model	Pairs	Color	Put up	SKU#
423C6-BL-B1K	4	Blue	1K Box	.10908
423C6-BL-S1K	4	Blue	1K Spool	.10685
423C6-WH-B1K	4	White	1K Box	.10909
423C6-WH-S1K	4	White	1K Spool	.3670
423C6-YL-S1K	4	Yellow	1K Spool	.1435

Category 6 PVC Shielded Cable

- 23 gauge
- UL rated
- 550Mhz



Model	Pairs	Color	Put up	SKU#
423C6S-GY-S1K	4	Gray	1K Spool	.18897

Category 6 Plenum

- 23 gauge
- UL, CMP rated



423C6P-WH-B1K shown

Model	Pairs	Color	Put up	SKU#
423C6P-BL-B1K	4	Blue	1K Box	.16238
423C6P-WH-B1K	4	White	1K Box	.9804

Category 5E Siamese

- 24 gauge
- PVC
- UL rated

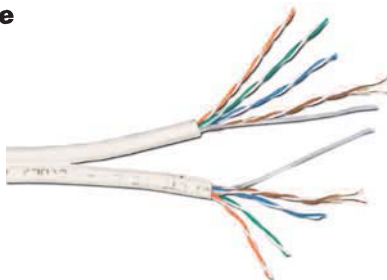

Model	Pairs	Color	Put up	SKU#
4424C5E-WH-S1K	4	White	1K Spool	.2905

Category 5E PVC

- 24 gauge
- 400 MHz
- UL rated
- 4 pair

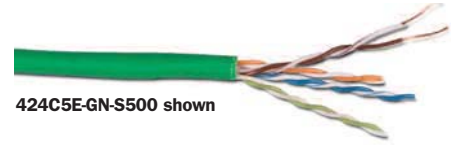

424C5E-GN-S500 shown

Model	Color	Put up	SKU#
424C5E-BL-B1K	Blue	1K Box	.1411
424C5E-BL-P500	Blue	500' Bag	.15807
424C5E-BL-S1K	Blue	1K Spool	.1867
424C5E-GN-B1K	Green	1K Box	.4976
424C5E-GN-P500	Green	500' Bag	.15142
424C5E-GN-S1K	Green	1K Spool	.7285
424C5E-GY-B1K	Gray	1K Box	.8175
424C5E-PU-B1K	Purple	1K Box	.5975
424C5E-WH-B1K	White	1K Box	.4979
424C5E-WH-P500	White	500' Bag	.15808
424C5E-YL-B1K	Yellow	1K Box	.6403
424C5E-YL-P500	Yellow	500' Bag	.15216

Category 5E PVC Shielded

- 24 gauge
- PVC
- UL rated



Model	Pairs	Color	Put up	SKU#
424C5ES-BL-B1K	4	Blue	1K Box	.8225

Category 5E Plenum

- 24 gauge
- PVC
- CMP rated
- UL rated

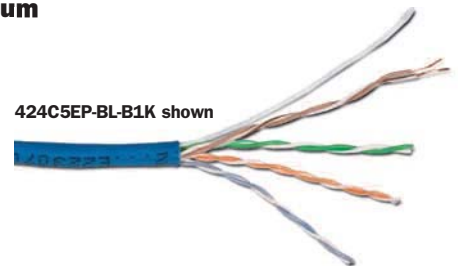

424C5EP-BL-B1K shown

Model	Pairs	Type	Color	Put up	SKU#
424C5EP-BL-B1K	4	Enhanced Cat5	Blue	1K Box	.7855
424C5EP-WH-R1K	4	Enhanced Cat5	White	1K RIB	.7370

Category 5E Direct Burial

- 24 gauge
- Black PVC sunlight resistant jacket
- Used for underground communications installations



424C5EB-BK-S1K shown

Model	Pairs	Type	Color	Put up	SKU#
424C5EB-BK-S1K	4	Enhanced Cat5	Black	1K Spool	.7837
424C5EB-BK-S2500	4	Enhanced Cat5	Black	2500' Spool	.15087

WIRE (CONTINUED)

Cresnet® Wire

- 18/2 Conductor with 22g, 1 pr shielded
- UL rated



Model	Color	Put up	SKU#
18222S-TL-S1K-CRESNET®	Teal w/Yellow Stripe	1K Spool	.10486

Cresnet® Control

- 18/2 Conductor with 22g, 1 pr shielded
- UL rated



Model	Gauge	Color	Put up	SKU#
CRESCAT-TL-S500	18+1C5E	Teal Blue	500' Spool	.15222
CRESNETD-TL-S500	18+2C5E	Teal Blue	500' Spool	.15221
CRESNETQ-TL-S500	18+4C5E	Teal Blue	500' Spool	.15220

Shielded Lighting Cable

- Designed to meet Lutron™ and Litetouch™ specs
- Sequential foot markers
- Nylon insulators
- UL 600V rated



182S600V-BL-S1K shown

Model	Gauge	Conductors	Type	Color	Put up	SKU#
182S600V-BL-S1K	18	2	Dimmer/Switch	Blue/Red	1K Spool	.6109
184S600V-TL-S1K	18	4	Keypad	White Stripe	1K Spool	.1348

Individual Pair Shielded Cables

- Shielded twisted pairs for control systems or line level runs
- Sequential foot markers
- UL rated CM, CL3

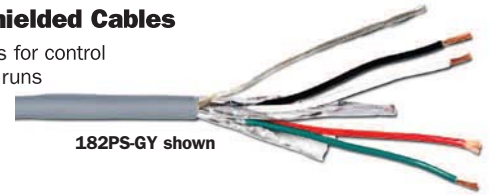

182PS-GY shown

Model	Gauge	Conductors	Color	Put up	SKU#
182PS-GY-S1K	18	2pr. + 1 Drain	Gray	1K Spool	.4841
222PS-GY-B1K	22	2pr. + 1 Drain	Gray	1K Box	.4866
222SPS-BL-S1K	22	2+1+2+1 Siamese	Blue	1K Spool	.3188

Audio Cable

- High quality audio transmission
- 99.9% Oxygen Free Copper
- Low capacitance cable



Model	Put up	SKU#
HQRS-A200	200' Spool	.2005

IR Control Wire

- Shielded multi-conductor cable with drain for use with IR keypads and control systems
- Sequential foot markers
- CM, CL3 rated
- UL rated



223S-BU shown

Model	Gauge	Conductors	Color	Put up	SKU#
184S-GY-S1K	18	4 + 1 Drain	Gray	1K Spool	.4846
222S-GY-B1K	22	2 + 1 Drain	Gray	1K Box	.1483
223S-BU-B1K	22	3 + 1 Drain	Burgundy	1K Box	.3305
224S-GY-B1K	22	4 + 1 Drain	Gray	1K Box	.5482

Cable and Wire Color Chart



Cable Substitution

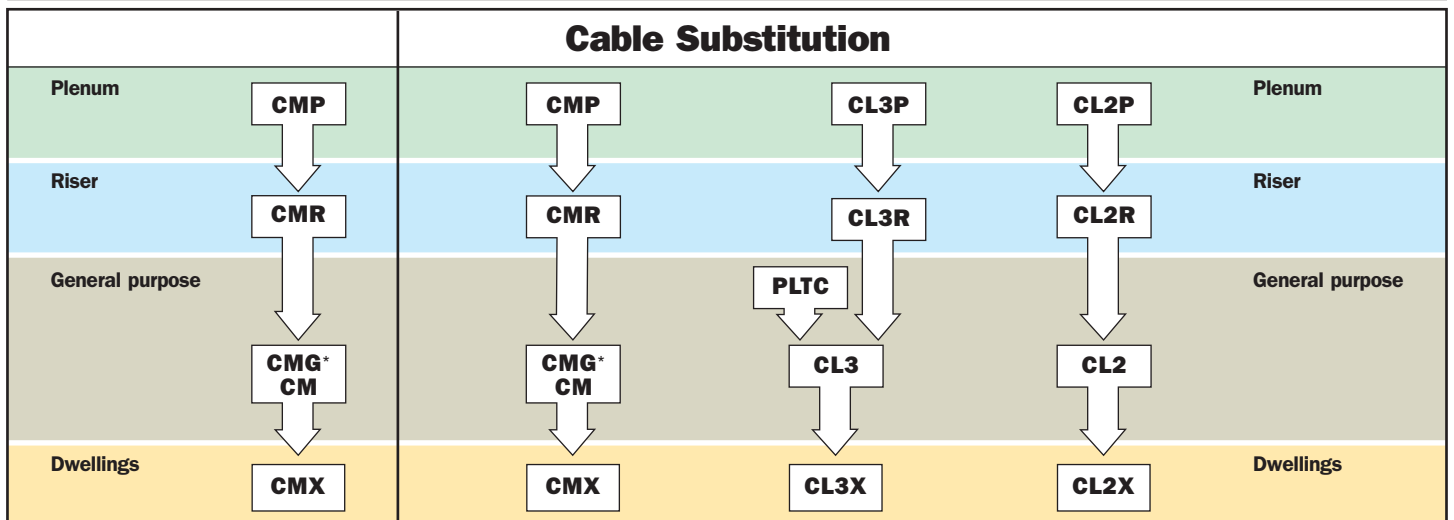

Type CM – Communications cables
Cable “A” – is permitted to be used in place of **Cable “B”**
***CMG** can be substituted for **CM**
CM can be substituted for **CMG**

Type CM – Communications Cables
Type CL2 and CL3 – Class 2 and Class 3 remote-control, signaling and power-limited cables
Type PLTC – Power-limited tray cable
Cable “A” is permitted to be used in place of **Cable “B”**
Please note: Cable and communication wire for premise installations in accordance with Article 800 and other sections of the National Electrical Code (NEC) latest issue

Tech Tip

Substitution can be made to higher class cable but not to a lower class cable.

VOLUME CONTROLS

Decorator Volume Control w/IR

- Control volume via infra-red remote
- 70 watts, 12 step impedance matching (1X, 2X, 4X, 8X with IR)
- Includes white decorator trim plate



Model VCIR70DSW/SKU# .10258

Outdoor Volume Control

- Weatherproof box for use outdoors
- 60 watts; impedance and non-impedance
- Uses standard trim plate; gray



Model VC060G/SKU# .13330

Slide Decorator Plate and Knob Kit

- Available in assorted colors



Model	Color	PKG	SKU#
VCSKKAL	Almond	20	.10569
VCSKKBR	Brown	20	.11071
VCSKKIV	Ivory	20	.10568

Decorator Volume Control

- Standard volume control
- 70 watts, 12 step impedance matching (1X, 2X, 4X, 8X with IR)
- Includes white decorator trim plate



Model VC70DSW/SKU# .3847

High-Power 6-Way Speaker Selector with Volume Controls

- Volume controls on each output channel
- Dual source
- 6-way



Model DSSV6-150W/SKU# .10525

Slide Decorator Volume Control

- Simply slide the knob to control volume
- 50 watts, 12 step impedance matching (1X, 2X, 4X, 8X with IR)
- Includes white decorator trim plate



Model VC50SDSW/SKU# .10527

Standard and Decorator Plate and Knob Kit

- Available in assorted colors

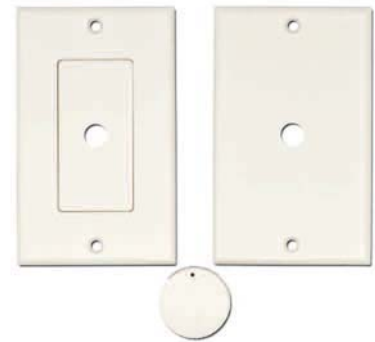

Model	Color	PKG	SKU#
VCKKAL	Almond	16	.10521
VCKKBR	Brown	16	.10523
VCKKIV	Ivory	16	.10522
VCKKLA	Lt. Almond	16	.12157

Decorator IR Knob Kit

- Available in assorted colors



Model	Color	Pkg	SKU#
VCIRKKAL	Almond	20	.12153
VCIRKKBR	Brown	20	.12154
VCIRKKIV	Ivory	20	.12155
VCIRKKLA	Lt. Almond	20	.12156

Standard and Decorator Volume Control, Plate, and Knob Kit

- Includes 70 watt decorator volume control
- Decorator and standard plates and knobs
- Impedance and non-impedance matching



Model VC70DSWIA-KIT/SKU# .14180

BULK WIRE PLATES

Single Gang Decorator Reversible Bulk Wire Plate

- Single gang bulk wire plates can accommodate approximately 10 RG6Q coaxial cables.



Model	Color	SKU#
DREV-AL	Almond	.19373
DREV-BK	Black	.19374
DREV-BR	Brown	.19634
DREV-IV	Ivory	.19375
DREV-LA	Lt. Almond	.19376
DREV-WH	White	.19372

Single Gang Hinged Bulk Wire Plate

- Designed for retro installations
- Allows a stylish bulk wire plate to be installed after the installation has been completed
- No need to disconnect any wires, just place the hinged plate in the appropriate position and snap the hinged bottom in place.



Model	Color	SKU#
S1GHBWP-AL	Almond	.20092
S1GHBWP-BK	Black	.20094
S1GHBWP-IV	Ivory	.20093
S1GHBWP-WH	White	.18235

Double Gang Standard Removable Raised Bulk Wire Plate

- Removable nose to allow flexibility during wire pull and installation
- Raised nose to allow more flexibility for placing wires in their desired position



Model	Color	SKU#
S2GRRBWP-AL	Almond	.14783
S2GRRBWP-BK	Black	.14784
S2GRRBWP-IV	Ivory	.14787
S2GRRBWP-WH	White	.14786

Single Gang Standard Reversible Bulk Wire Plate

- Single gang bulk wire plates can accommodate approximately 10 RG6Q coaxial cables.



Model	Color	SKU#
S1REV-AL	Almond	.19367
S1REV-BK	Black	.19368
S1REV-IV	Ivory	.19369
S1REV-LA	Lt. Almond	.19370
S1REV-WH	White	.19371

Single Gang Decorator Bulk Wall Plate

- Single gang bulk wire plates can accommodate approximately 10 RG6Q coaxial cables



Model	Color	SKU#
D1GRBWP-IV	Ivory	.10401
D1GRBWP-WH	White	.10400

Double Gang Removable Bulk Wire Plate

- Removable nose to allow flexibility during wire pull and installation



Model	Color	SKU#
S2GRBWP-AL	Almond	.14016
S2GRBWP-BK	Black	.14017
S2GRBWP-IV	Ivory	.14015
S2GRBWP-WH	White	.14014

Single Gang Standard Removable Raised Bulk Wire Plate

- Removable nose to allow flexibility during wire pull and installation
- Raised nose to allow more flexibility for placing wires in their desired position



Model	Color	SKU#
S1GRRBWP-AL	Almond	.14779
S1GRRBWP-BK	Black	.14780
S1GRRBWP-IV	Ivory	.14781
S1GRRBWP-LA	Lt. Almond	.17923
S1GRRBWP-WH	White	.14782

Single Gang Ribbon Cable Plates

- Single gang plate for installation of ribbon cables



Model	Color	SKU#
SSAT-IV	Ivory	.2699
SSAT-WH	White	.2902

Double Gang Hinged Bulk Wire Plate

- Designed for retro installations
- Allows a stylish bulk wire plate to be installed after the installation has been completed
- No need to disconnect any wires, just place the hinged plate in the appropriate position and snap the hinged bottom in place



Model	Color	SKU#
S2GHBWP-AL	Almond	.20095
S2GHBWP-BK	Black	.20097
S2GHBWP-IV	Ivory	.20096
S2GHBWP-WH	White	.19568

Single Gang Standard Removable Bulk Wire Plate

- Removable nose to allow flexibility during wire pull and installation



Model	Color	SKU#
S1GRBWP-AL	Almond	.14012
S1GRBWP-BK	Black	.14013
S1GRBWP-IV	Ivory	.14011
S1GRBWP-WH	White	.14010

Double Gang Standard Reversible Bulk Wire Plate

- Double gang bulk wire plates can accommodate approximately 16 RG6Q coaxial cables



Model	Color	SKU#
S2REV-AL	Almond	.20117
S2REV-BK	Black	.20118
S2REV-BR	Brown	.20119
S2REV-IV	Ivory	.20120
S2REV-LA	Lt. Almond	.20121
S2REV-WH	White	.19565

Double Gang Fixed Bulk Wire Plate

- Double gang bulk wire plates can accommodate approximately 16 RG6Q coaxial cables



Model	Color	SKU#
S2GBWP-BK	Black	.10408
S2GBWP-WH	White	.6911

SPECIALTY PLATES

Decorator HDMI™ Plate

- Single 90° HDMI™ jack built in to a decorator plate



Model	Color	SKU#
DHDMIS-WH-90	White	.13460

Stainless Steel SVGA Plate



Model	Color	SKU#
SSVGA-SS	Stainless Steel	.9627

Standard Keystone 4-Port SVGA Plate

- Includes SVGA connector with a 4-port standard plate



patented

Model	Color	SKU#
KP4SVGA-BK	Black	.10712
KP4SVGA-IV	Ivory	.10715
KP4SVGA-WH	White	.10713

Decorator Home Theater 6.2 Plate

- Designed to connect a 6.2 home theater system into one convenient decorator wall plate
- Screw terminals



Model	Color	SKU#
DHT6.2	White	.12568

Decorator HDMI™ Plate

- Single 180° HDMI™ jack built in to a decorator plate



Model	Color	SKU#
DHDMIS-WH-180	White	.13459

Decorator Keystone 4-Port SVGA Plate

- Includes 4 port keystone inserts along with a fixed SVGA connection port



patent pending

Model	Color	SKU#
DK4SVGA-BK	Black	.15603
DK4SVGA-WH	White	.15604

Standard Cresnet® Plate Kit

- Includes 2-KC5E and 2 F-inserts



patented

Model	Color	SKU#
SCN5-KIT-BK	Black	.13493
SCN5-KIT-WH	White	.13491

HDMI™ to HDMI™ 6" Keystone Pigtail

- Flexible pigtail designed to easily bend when minimal clearance is available
- Designed to be inserted into a keystone plate to provide a finished look
- Available in Female to Female or Male to Female



Decorator Keystone 2-Port SVGA Plate

- Accommodates dual keystone inserts along with a fixed SVGA connection port



patented

Model	Color	SKU#
DK2SVGA-BK	Black	.10747
DK2SVGA-WH	White	.10769

Decorator Keystone SVGA and Dual RCA Plate Kit

- Includes dual RCA keystone inserts along with a fixed SVGA connection port



patented

Model	Color	SKU#
DSVGA-WH-GOLD	Kit White	.12171

Standard Plate with 6 F-Connectors and 2 Keystone Ports



Model	Color	SKU#
S6F2K-LA	Lt. Almond	.18427

Model	Color	SKU#
HDMIKPT	White	.17259
HDMIKPTMF	White	.17905

WALL PLATES AND CONNECTORS

Decorator Platform

- Blank module for decorator style
- Use with DC connectors

1-PORT		
Model	Color	SKU#
D1-AL	Almond	.6464
D1-IV	Ivory	.6395
D1-WH	White	.6398
2-PORT		
D2-AL	Almond	.6596
D2-IV	Ivory	.5604
D2-WH	White	.6400
3-PORT		
D3-AL	Almond	.4447
D3-IV	Ivory	.4453
D3-WH	White	.4454
4-PORT		
D4-AL	Almond	.4455
D4-IV	Ivory	.4460
D4-WH	White	.4462
6-PORT		
D6-AL	Almond	.4480
D6-IV	Ivory	.4489
D6-WH	White	.4493
8-PORT		
D8-AL	Almond	.4512
D8-IV	Ivory	.4519
D8-WH	White	.4521

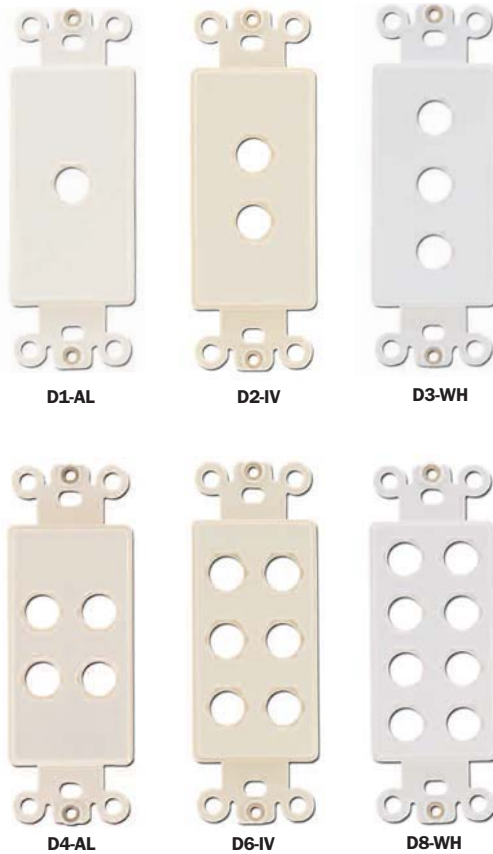

Connector Plate

- Blank module for standard style
- Use with DC connectors

1-PORT		
Model	Color	SKU#
S1-IV	Ivory	.6599
S1-WH	White	.5885
2-PORT		
S2-AL	Almond	.187
S2-IV	Ivory	.191
S2-WH	White	.193
2-PORT		
S3-WH	White	.5888
4-PORT		
S4-WH	White	.4476
6-PORT		
S6-WH	White	.4509
8-PORT		
S8-IV	Ivory	.4528
S8-WH	White	.4530

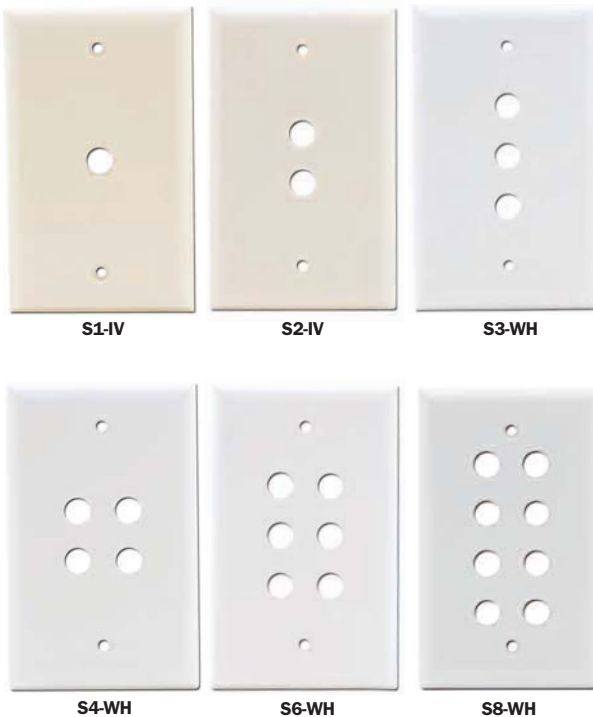

Keystone Insert Accessories

Snap-on insert with 3/8" hole

- Allows you to place a variety of chassis mount connectors in KP or DK series plates

Model	Color	SKU#
DK38-AL	Almond	.11697
DK38-BK	Black	.11698
DK38-BR	Brown	.11699
DK38-IV	Ivory	.11700
DK38-LA	Light Almond	.11701
DK38-WH	White	.11702



5-way binding post

- Gold plated, Sold as pair (red, blk)

Model 5WBP-G
SKU# .4534



Female F connector

- Gold plated

Model F-G
SKU# .5881



Female RCA jack

- Gold plated

Model RCAFS-G
SKU# .5883



DCGOLDNUT

- Smaller size nut for Keystone Insert

Model GOLDNUT
SKU# .10556



RCA F-F

Bulkhead connector

- Gold finish

Model	Color	SKU#
RFNRF-G-BK	Black	.9692
RFNRF-G-BL	Blue	.9693
RFNRF-G-GR	Green	.9694
RFNRF-G-YL	Yellow	.2110
RFNRF-G-RD	Red	.4907
RFNRF-G-WH	White	.8402



Banana jack

- Gold plated

Model 5WBJ-G
SKU# .4536



RCA to F

- Gold plated

Model FFRF-G
SKU# .4539



3.5mm F-F bulk-head connector

- Nickel plated

Model 35FC35F-N
SKU# .6035



WALL PLATES AND CONNECTORS (CONTINUED)

Decorator Keystone

- Use with DC trim plates and inserts
- Available in economy 10 packs

1-PORT

Model	Color	SKU#
DK1-AL	Almond	.5404
DK1-BK	Black	.11355
DK1-BR	Brown	.5405
DK1-IV	Ivory	.2763
DK1-LA	Lt. Almond	.11138
DK1-WH	White	.2761



2-PORT

Model	Color	SKU#
DK2-AL	Almond	.5407
DK2-BK	Black	.11354
DK2-BR	Brown	.5409
DK2-IV	Ivory	.1524
DK2-LA	Lt. Almond	.11139
DK2-WH	White	.1523

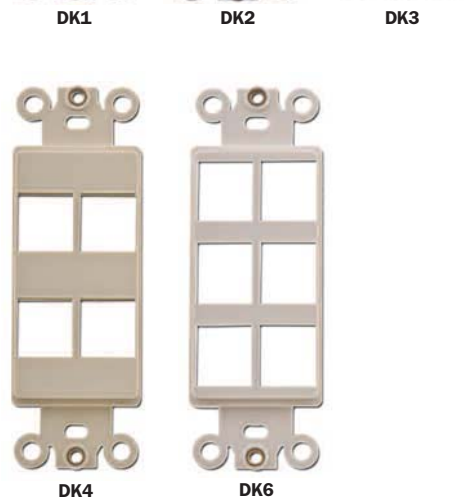

3-PORT

Model	Color	SKU#
DK3-AL	Almond	.5411
DK3-BK	Black	.11353
DK3-BR	Brown	.5415
DK3-IV	Ivory	.1521
DK3-LA	Lt. Almond	.11140
DK3-WH	White	.1520

4-PORT

Model	Color	SKU#
DK4-AL	Almond	.11352
DK4-BK	Black	.11351
DK4-BR	Brown	.11350
DK4-IV	Ivory	.11349
DK4-LA	Lt. Almond	.11141
DK4-WH	White	.9907

6-PORT

Model	Color	SKU#
DK6-AL	Almond	.11965
DK6-BK	Black	.11970
DK6-BR	Brown	.11966
DK6-IV	Ivory	.11967
DK6-LA	Lt. Almond	.11969
DK6-WH	White	.11968

Keystone Plates with Label

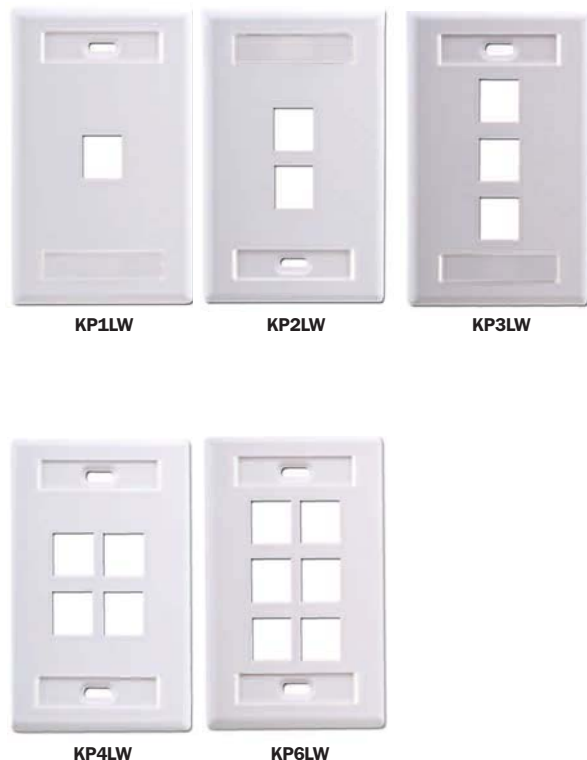

Port	Model	Color	SKU#
1 port	KP1LW-WH	White	.11479
2 port	KP2LW-WH	White	.11481
3 port	KP3LW-WH	White	.11482
4 port	KP4LW-WH	White	.11483
6 port	KP6LW-WH	White	.11484

Decorator Trim Plate

- Single gang



Model	Color	SKU#
DT1G-AL	Almond	.10759
DT1G-BK	Black	.10762
DT1G-BR	Brown	.10761
DT1G-IV	Ivory	.10758
DT1G-LA	Lt. Almond	.10760
DT1G-WH	White	.10757

Decorator Trim Plate

- Double gang



Model	Color	SKU#
DT2G-AL	Almond	.10765
DT2G-BK	Black	.10768
DT2G-BR	Brown	.10767
DT2G-IV	Ivory	.10764
DT2G-LA	Lt. Almond	.10766
DT2G-WH	White	.10763

Decorator Trim Plate

- Triple gang

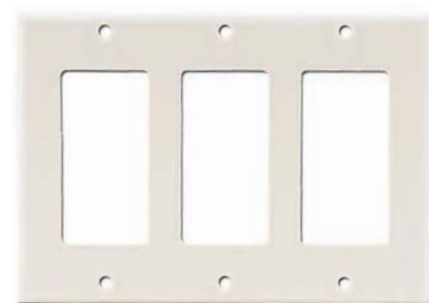

Model	Color	SKU#
DT3G-AL	Almond	.11975
DT3G-BK	Black	.11976
DT3G-BR	Brown	.11977
DT3G-IV	Ivory	.11978
DT3G-LA	Lt. Almond	.11979
DT3G-WH	White	.11980

WALL PLATES AND CONNECTORS (CONTINUED)

Keystone Plate

- Use with DC modules
- Available in economy 10 packs

1-PORT

Model	Color	SKU#
KP1-AL	Almond	.4557
KP1-BK	Black	.10723
KP1-BR	Brown	.4556
KP1-IV	Ivory	.4628
KP1-LA	Lt. Almond	.10509
KP1-WH	White	.384

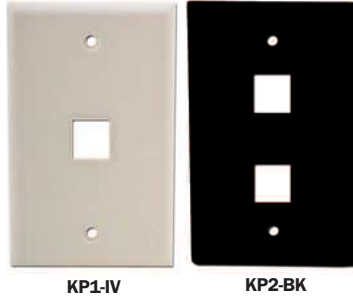

2-PORT

Model	Color	SKU#
KP2-AL	Almond	.4567
KP2-BK	Black	.10724
KP2-BR	Brown	.4564
KP2-IV	Ivory	.6738
KP2-LA	Lt. Almond	.10510
KP2-WH	White	.3917

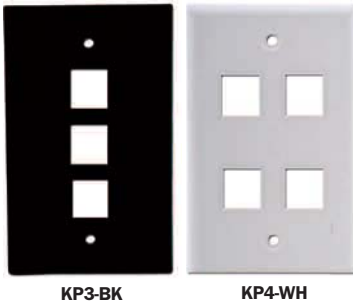

3-PORT

Model	Color	SKU#
KP3-AL	Almond	.4571
KP3-BK	Black	.10725
KP3-BR	Brown	.4569
KP3-IV	Ivory	.3945
KP3-LA	Lt. Almond	.10511
KP3-WH	White	.3942



4-PORT

Model	Color	SKU#
KP4-AL	Almond	.4582
KP4-BK	Black	.10726
KP4-BR	Brown	.4579
KP4-IV	Ivory	.4633
KP4-LA	Lt. Almond	.10512
KP4-WH	White	.3948

6-PORT

Model	Color	SKU#
KP6-AL	Almond	.4585
KP6-BK	Black	.10727
KP6-BR	Brown	.4583
KP6-IV	Ivory	.1994
KP6-LA	Lt. Almond	.10513
KP6-WH	White	.3955

Oversized Keystone Standard Plate

- Use with DC modules

1-PORT

Model	Color	SKU#
KP01-IV	Ivory	.16187
KP01-LA	Lt. Almond	.16192
KP01-WH	White	.14373

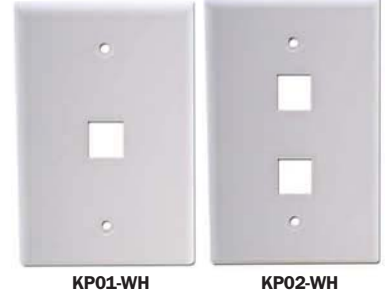

2-PORT

Model	Color	SKU#
KP02-IV	Ivory	.16188
KP02-LA	Lt. Almond	.16193
KP02-WH	White	.14374



3-PORT

Model	Color	SKU#
KP03-IV	Ivory	.16189
KP03-LA	Lt. Almond	.16194
KP03-WH	White	.14375

4-PORT

Model	Color	SKU#
KP04-IV	Ivory	.16190
KP04-LA	Lt. Almond	.16195
KP04-WH	White	.14376

6-PORT

Model	Color	SKU#
KP06-IV	Ivory	.16191
KP06-LA	Lt. Almond	.16196
KP06-WH	White	.14377



Decorator Keystone Gold F-Connector

- For use with keystone plates
- F-Connector included (long barrel)



Model	Color	SKU#
DKFG-WH	White	.13983

Decorator Keystone F3GHz Gold Connector



Model	Color	SKU#
DKF3G-AL	Almond	.15968
DKF3G-BK	Black	.15969
DKF3G-BR	Brown	.15970
DKF3G-IV	Ivory	.15971
DKF3G-LA	Lt. Almond	.15972
DKF3G-WH	White	.15973

Decorator Keystone Snap-on Blanks

- For use with keystone plates
- Sold as each



Model	Color	SKU#
DKB-AL	Almond	.11690
DKB-BK	Black	.11691
DKB-BR	Brown	.11692
DKB-IV	Ivory	.11693
DKB-LA	Lt. Almond	.11694
DKB-WH	White	.11695

Decorator Keystone F-Connector

- Economy 10 Packs
- For use with keystone plates
- F-Connector included (short barrel)



Model	Color	SKU#
DKFE-AL-10	Almond	.15962
DKFE-BK-10	Black	.15963
DKFE-BR-10	Brown	.15964
DKFE-IV-10	Ivory	.15965
DKFE-LA-10	Lt. Almond	.15966
DKFE-WH-10	White	.15967

K38 Snap-on Insert

- Snap-on insert with hole
- Place a variety of chassis mount connectors in keystone plates or decorator keystone plates



Model	Color	SKU#
DK38-AL	Almond	.11697
DK38-BK	Black	.11698
DK38-BR	Brown	.11699
DK38-IV	Ivory	.11700
DK38-LA	Lt. Almond	.11701
DK38-WH	White	.11702

Decorator Keystone Snap-on Blanks

- Economy 10 Packs
- For use with keystone plates



Model	Color	SKU#
DKB-AL-10	Almond	.4561
DKB-BK-10	Black	.10720
DKB-BR-10	Brown	.4558
DKB-IV-10	Ivory	.16804
DKB-LA-10	Lt. Almond	.10517
DKB-WH-10	White	.3962

WALL PLATES AND CONNECTORS (CONTINUED)

Keystone CAT6 Jacks

- 110 termination
- For use with keystone plates



Model	Color	SKU#
KC6-AL	Almond	.8638
KC6-BK	Black	.10722
KC6-BL	Blue	.8641
KC6-BR	Brown	.8639
KC6-IV	Ivory	.8637
KC6-LA	Lt. Almond	.11366
KC6-RD	Red	.13891
KC6-WH	White	.8636
KC6-YL	Yellow	.8640

Keystone CAT6 Easy Crimp Jacks

- No tools required
- Reusable
- 11 assorted colors
- 110 termination
- For use with keystone plates

patented



Model	Color	SKU#
KC6EZ-AL	Almond	.15989
KC6EZ-BK	Black	.15990
KC6EZ-BL	Blue	.15991
KC6EZ-BR	Brown	.15992
KC6EZ-GN	Green	.15993
KC6EZ-IV	Ivory	.15994
KC6EZ-LA	Lt. Almond	.15995
KC6EZ-OR	Orange	.15996
KC6EZ-RD	Red	.15997
KC6EZ-WH	White	.15998
KC6EZ-YL	Yellow	.15999

Keystone CAT5 Easy Crimp Jacks

- No tools required
- Reusable
- 11 assorted colors
- 110 termination
- For use with keystone plates

patented



Model	Color	SKU#
KC5EZ-AL	Almond	.14240
KC5EZ-BK	Black	.14241
KC5EZ-BL	Blue	.14246
KC5EZ-BR	Brown	.14242
KC5EZ-GN	Green	.14247
KC5EZ-IV	Ivory	.14243
KC5EZ-LA	Lt. Almond	.14244
KC5EZ-OR	Orange	.14248
KC5EZ-RD	Red	.14249
KC5EZ-WH	White	.14239
KC5EZ-YL	Yellow	.14245

Category 5 Enhanced Jacks – Economy 10 Packs

- 110 termination
- For use with keystone plates



Model	Color	Label	SKU#
KC5E-AL-10	Almond	Cat5E	.16798
KC5E-BK-10	Black	Cat5E	.16799
KC5E-BR-10	Brown	Cat5E	.16800
KC5E-IV-10	Ivory	Cat5E	.16801
KC5E-LA-10	Lt. Almond	Cat5E	.16802
KC5E-WH-10	White	Cat5E	.16803

Keystone CAT5 Enhanced Jacks

- 110 termination
- For use with keystone plates



Model	Color	Label	SKU#
KC5E-AL	Almond	Cat5E	.4577
KC5E-BK	Black	Cat5E	.5011
KC5E-BL	Blue	Cat5E	.4550
KC5E-BR	Brown	Cat5E	.4574
KC5E-GR	Green	Cat5E	.4552
KC5E-IV	Ivory	Cat5E	.1128
KC5E-LA	Lt. Almond	Cat5E	.10514
KC5E-OR	Orange	Cat5E	.4546
KC5E-PU	Purple	Cat5E	.15241
KC5E-RD	Red	Cat5E	.4126
KC5E-WH	White	Cat5E	.1126
KC5E-YL	Yellow	Cat5E	.4548
KC5EV-WH	White	Voice	.6877
KC5ED-WH	White	Data	.6878

Keystone CAT3, 6 PIN

- 110 termination
- For use with keystone plates



Model	Color	SKU#
KC36-AL	Almond	.9780
KC36-BK	Black	.1133
KC36-BL	Blue	.11507
KC36-BR	Brown	.9781
KC36-GR	Green	.11510
KC36-IV	Ivory	.1132
KC36-LA	Lt. Almond	.11005
KC36-OR	Orange	.11509
KC36-WH	White	.1130

Keystone CAT5E Coupler Straight for Data

- Modular cord couplers



Model	Color	SKU#
KC5EF-BK	Black	.7599
KC5EF-WH	White	.13496

Keystone USB Coupler Jack



Model	Color	SKU#
KUSB-BK	Black	.18208

Keystone HDMI™ to HDMI™ Pigtail

- Flexible pigtail designed to easily bend when minimal clearance is available
- Designed to be inserted into a keystone plate to provide a finished look
- Length = 6"
- Available in Female to Female or Male to Female



Model	Color	SKU#
HDMIKPT	White	.17259
HDMIKPTMF	White	.17905

Clips and Reducers for Easy Crimp Jacks



Clips/Model	Pkg	SKU#
KC5EZ-Insert-100	100	.16153
KC5EZ-Insert-10	10	.16213
Reducers/Model	Pkg	SKU#
KC5EZ-Reducer-100	100	.16163
KC5EZ-Reducer-10	10	.16212

Decorator Keystone F-Connector

- For use with keystone plates
- F-Connector included (long barrel)



Model	Color	SKU#
DKF-AL	Almond	.11703
DKF-BK	Black	.11704
DKF-BR	Brown	.11705
DKF-IV	Ivory	.11706
DKF-LA	Lt. Almond	.11707
DKF-OR	Orange	.11708
DKF-WH	White	.11709

WALL PLATES AND CONNECTORS (CONTINUED)

Keystone CAT5 Easy Crimp



Model	Color	SKU#
USPLATEKIT-BR	Brown	.17492
USPLATEKIT-LA	Lt. Ivory	.17493
USPLATE-WH	White	.17414
USPLATEKIT-WH	White	.16202
USPLATEKIT2-BR	Brown	.17417
USPLATEKIT2-LA	Lt. Ivory	.17416
USPLATEKIT2-WH	White	.17415

New product arrivals

Keystone CAT6 Easy Crimp Jacks

- No tools required
- Reusable
- 11 assorted colors
- 110 termination
- For use with keystone plates



patented

Model	Color	SKU#
KC6EZ-AL	Almond	.15989
KC6EZ-BK	Black	.15990
KC6EZ-BL	Blue	.15991
KC6EZ-BR	Brown	.15992
KC6EZ-GN	Green	.15993
KC6EZ-IV	Ivory	.15994
KC6EZ-LA	Lt. Almond	.15995
KC6EZ-OR	Orange	.15996
KC6EZ-RD	Red	.15997
KC6EZ-WH	White	.15998
KC6EZ-YL	Yellow	.15999

Keystone CAT5 Easy Crimp Jacks

- No tools required
- Reusable
- 11 assorted colors
- 110 termination
- For use with keystone plates



patented

Model	Color	SKU#
KC5EZ-AL	Almond	.14240
KC5EZ-BK	Black	.14241
KC5EZ-BL	Blue	.14246
KC5EZ-BR	Brown	.14242
KC5EZ-GN	Green	.14247
KC5EZ-IV	Ivory	.14243
KC5EZ-LA	Lt. Almond	.14244
KC5EZ-OR	Orange	.14248
KC5EZ-RD	Red	.14249
KC5EZ-WH	White	.14239
KC5EZ-YL	Yellow	.14245

Decorator 4-Conductor Phone Jack



Model	Color	SKU#
DPH-IV	Ivory	.1303
DPH-WH	White	.2627
DPH-LA	Lt. Almond	.19688

Decorator Coax and Phone Jack

- One F-connector and one 6 conductor phone jack in a decorator style plate



Model	Color	SKU#
DPHF-IV	Ivory	.3802
DPHF-WH	White	.3806
DPHF-LA	Lt. Almond	.19686

Standard 1 Gang Blank Plate



Model	Color	SKU#
SBLANK-AL	Almond	.12604
SBLANK-BK	Black	.12605
SBLANK-BR	Brown	.12606
SBLANK-IV	Ivory	.12607
SBLANK-LA	Lt. Almond	.12026
SBLANK-WH	White	.11447

Decorator Blank Insert



Model	Color	SKU#
DBLANK-IV	Ivory	.3854
DBLANK-WH	White	.4978

Decorator F-Connector Coax Jack

- One F-connector in a decorator style plate



Model	Color	SKU#
DF-IV	Ivory	.2159
DF-WH	White	.2163
DF-AL	Almond	.9786

Standard 2 Gang Blank Plate



Model	Color	SKU#
S2GBLANK-AL	Almond	.15553
S2GBLANK-BK	Black	.15554
S2GBLANK-BR	Brown	.15555
S2GBLANK-IV	Ivory	.15556
S2GBLANK-LA	Lt. Almond	.12028
S2GBLANK-WH	White	.12027

WALL PLATES AND CONNECTORS (CONTINUED)

Standard 4-Conductor Phone Jack



Model	Color	SKU#
SPH-AL	Almond	.5655
SPH-BR	Brown	.3572
SPH-IV	Ivory	.3566
SPH-LA	Lt. Almond	.10519
SPH-WH	White	.3569

Economy SKUS		
SPHE-WH	White	.10357

Standard F-Connector Plate

- Single F-connector in standard style plate



Model	Color	SKU#
SF-AL	Almond	.5660
SF-BR	Brown	.2573
SF-IV	Ivory	.1385
SF-LA	Lt. Almond	.10518

SF-WH	White	.2570
-------	-------	-------

Economy SKUS		
SP81E-WH	White	.9033

Oversized F-Connector Plate

- Wider than standard size plates



Model	Color	SKU#
SOF-WH	White	.10906

Standard 4-Conductor Dual Phone Jack



Model	Color	SKU#
SPH2-AL	Almond	.5657
SPH2-IV	Ivory	.905
SPH2-WH	White	.547

Standard Dual F-Connector Plate

- Dual F-connector in standard style plate



Model	Color	SKU#
SF2-AL	Almond	.5664
SF2-IV	Ivory	.1102
SF2-WH	White	.1390

Standard Coax and Phone Plate

- Single F-connector and single 4-conductor phone plate



Model	Color	SKU#
SPHF-AL	Almond	.5661
SPHF-IV	Ivory	.4298
SPHF-LA	Lt. Almond	.12566
SPHF-WH	White	.6050

Wall Mount Phone Jack

- Available in plastic or stainless steel



Model	Color	SKU#
WPH-AL	Almond	.5718
WPH-IV	Ivory	.6374
WPH-LA	Lt. Almond	.15167
WPH-SS	Stainless Steel	.1299
WPH-WH	White	.2925

Standard 3 GHz Dual F-Connector Plate

- Dual F-connectors 3GHz in standard style plate



Model	Color	SKU#
SF23G-IV	Ivory	.13982
SF23G-WH	White	.13981

Standard Dual Coax and Phone Plate

- Dual F-connector and single 4-conductor phone plate
- Ideal for DSS installations



Model	Color	SKU#
SDSS-AL	Almond	.5663
SDSS-BR	Brown	.6433
SDSS-IV	Ivory	.5471
SDSS-WH	White	.3033

Oversized 4-Conductor Phone Jack

- Wider than standard size plates



Model	Color	SKU#
SOPH-WH	White	.10905

Standard 3 GHz F-Connector Economy Plate

- Single F-connector 3GHz in standard style plate



Model	Color	SKU#
SF81E3G-IV	Ivory	.13980
SF81E3G-WH	White	.13979

Decorator Dual Coax and Phone Plate

- Dual F-connector and single 4-conductor phone plate
- Ideal for DSS installations



Model	Color	SKU#
DDSS-IV	Ivory	.5474
DDSS-WH	White	.3017

IR Surface Mount Kit

- Surface mount IR receiver
- Connecting block
- 4 emitters
- Power supply



Model IR-Kit/SKU# .14051

IR Flush Mount Kit

- Flush mount IR receiver
- 4-way connecting block
- 4 emitters
- Power supply



Model IR-Kit2/SKU# .14068

IR Table Top Kit

- Table Top IR receiver
- 4-way connecting block
- 4 emitters
- Power supply



Model IR-Kit3/SKU# .15195

IR Kit

- 4-way connecting block
- 4 mini dual emitters with talk-back
- Power supply



Model IR-Kit4/SKU# .15364

IR Surface Mount Receiver – Black



Model IRRSMS/SKU# .13329

IR J-Box Flush Mount Receiver



Model IRRJB/SKU# .13538

Single Mini Emitter

- 10 ft cable with plug
- 20/200 pk.



Model IRE1S/SKU# .11818

IR Surface Mount Receiver – White



Model IRRSM-WH/SKU# .13977

IR Connecting Block

- 4-way



Model IRCB4/SKU# .11820

Single Mini Emitter with Talk-back

- 10 ft cable with plug
- 20/200 pk.



Model IRE1TB/SKU# .12479

IR Flush Mount Receiver – Brass



Model IRRFM/SKU# .13209

IR Power Supply 500MA



Model IRPS/SKU# .7853

Dual Mini Emitter

- 10 ft cable with plug
- 20/200 pk.



Model IRE2/SKU# .11819

IR Table-Top Receiver – Black



Model IRRTTB/SKU# .15143

Mini Emitter Shell Cover



Model IRS1/SKU# .16492

Dual Mini Emitter with Talk-back

- 10 ft cable with plug
- 20/200 pk.



Model IRE2TB/SKU# .12480

CONNECTORS

Dual Banana Plug

- Pro Series 4.0mm banana plug
- For use with 9-16 gauge wire
- Gold plated
- Copper leaf springs



Model	Color	SKU#
DBPRO-RD	Red	.2547
DBPRO-BK	Black	.7426

Dual Banana Plug

- Gold plated



Model	Color	SKU
DBM-RD	Red	.4307
DBM-BK	Black	.4311

Crimp-on Banana Plug

- 4.0mm banana plug
- For use with 12-16 gauge wire
- Gold plated
- Sold in pairs (1 red, 1 black)



Model BPCRMP-G/SKU# .4079

Banana Plug - Gold

- Gold plated
- Red, Black pair



Model BPG/SKU# .4929

5-Way Binding Post

- Gold plated
- Sold in pairs (red, blk)



Model 5WBP-G/SKU# .4534

Banana Jack

- Gold plated



Model 5WBJ-G/SKU# .4536

F-Connector RG59

- Sold in 100 packs



Model	Color	SKU#
F59290G	Cad/Brass	.4075
F59290T	Tin	.2427

Spade Terminals

- For use with 12-16 gauge wire
- Gold plated
- Sold in pairs (1 red, 1 black)



Model SL/SKU# .4291

Female to Female F-Connector - Nickel

- Complete with nut and washer
- Sold in 100 packs



Model F81N/SKU# .2463

F-Connector to RCA Connector - Gold

- Female F-Connector to Female RCA connector
- Gold plated



Model FFRFG/SKU# .4539

F-Connector RG59 Plenum

- Sold in 100 packs



Model F59P/SKU# .3170

Female to Female F-Connector - XL Nickel

- Extra long length
- Complete with nut and washer
- Sold in 100 packs



Model F81NWL/SKU# .290

F-Connector to RCA Connector - Nickel

- Female F-Connector to Female RCA connector
- Nickel plated



Model FFRFN/SKU# .2535

F-Connector to RCA Connector - Bulkhead

- Female F-Connector to Female RCA connector
- Gold plated



Model	Color	SKU#
FFNRF-G-BK	Black	.16466
FFNRF-G-BL	Blue	.16467
FFNRF-G-GN	Green	.16468
FFNRF-G-RD	Red	.16469
FFNRF-G-WH	White	.16470
FFNRF-G-YL	Yellow	.16471

F-Connector RG6Q

- For use with RTC-1 tool
- True 75 ohm
- NRO series includes O-ring for dirt and moisture protection
- Exceptional pullout strength
- Sold in 100 packs



Model	Color	SKU#
F56342NR-T	Tin	.137
F56342NRO-T	Tin	.1531

with O-ring

Female to Female F-Connector - 3GHz - Nickel

- Complete with nut and washer
- Sold in 100 packs



Model F813GHZ/SKU# .4030

Male to Male F-Connector - Nickel

- Nickel
- Sold in 100 packs



Model F71N/SKU# .2554

Female to Female F-Connector - Gold

- Gold plated
- Fits DirectConnect® series plates
- Bulk package contains 12 connectors



Model FG/SKU# .5881

Female Right Angle F-Connector to F-Connector Male - Nickel

- Nickel



Model F90N/SKU# .5849

Connector Codes Explained

General Rules:

1. Female part numbers always come first alphabetically.
2. The descriptions of each end are also alphabetical (i.e. BFFF), the BF is before FF.

Example: FFRM
"F" female to
RM=RCA male



SKU# .2520

Codes:

FF= "F" female
RF= RCA female
BF= BNC female
FM= "F" male
RM= RCA male
BM= BNC male

P= Plenum
MP= Motorola plug
C= Crimp or Chassis
T= Tin/Nickel
G= Gold/Brass

Example: BM358
BM = BNC male
3 = Three piece
58= Used
with RG58



SKU# .9582

CONNECTORS (CONTINUED)

F-Connector RG6Q

- Sold in 100 packs



Model	Color	SKU#
F56324G	Cad/Brass	.4078
F56324T	Tin	.2431

F-Connector Twist-on – Nickel Nickel

- Sold in 100 packs



Model	Type	SKU#
FT059-N	RG-59	.2445
FT056-N	RG-6	.2457

Female RCA to Male F-Connector – Nickel

- Nickel



Model RFFMN/SKU# .2541

RG59 Compression F-Connectors



Model	Color	SKU#
SOF59UG	Gold	.10220
SOF59UN	Nickel	.10219

F-Connector RG6Q or RG6 Tri-Shield

- Sold in 100 packs



Model	Color	SKU#
F56342G	Cad/Brass	.4094
F56342N	Nickel	.6329

Gold Nut

- Smaller size nut for Keystone insert
- Gold



Model GOLDNUT/SKU# .10556

Female F-Connector to Male BNC – Nickel

- Nickel



Model FFBMN/SKU# .2510

RCA Compression Connectors



Model	Color	SKU#
SORCA6U-G	Gold	.10230
SORCA6U-N	Nickel	.10229
SORCA23-G	Gold	.12602

F-Connector RG6Q

- Sold in 100 packs



Model	Color	SKU#
F56357G	Cad/Brass	.6150
F56357T	Tin	.3381

Grounding Blocks



Model	Type	SKU#
GRB1	Single	.2467
GRB2	Dual	.1078

Female F-Connector to 3.5mm Mono Plug

- Nickel



Model FF35MN/SKU# .1857

RCA Compression Connectors



Model	Color	SKU#
SORCA59U-G	Gold	.10228
SORCA59U-N	Nickel	.10227

F-Connector RG6Q Plenum

- Sold in 100 packs



Model F56P/SKU# .1678

Dual Grounding Block – 2.3GHz



Model GRB22 GHTZ/SKU# .7962

Female BNC to Male F-Connector

- Nickel



Model BFFM/SKU# .2654

F-Connector to Push-on RG59 Connector

- Sold in 100 packs
- Female F-connector to push-on RG59 male



Model PF59N/SKU# .2448

Female F-Connector to Male RCA – Nickel

- Nickel
- Sold in 100 packs



Model FFRMN/SKU# .2520

Terminator

- 2GHz
- Sold in 100 packs



Model F59T/SKU# .2441

BNC Compression Connectors



Model	Color	SKU#
SOBNC6U-G	Gold	.10226
SOBNC6U-N	Nickel	.10225

F-Connector RG6Q Twist-on – Nickel

- Sold in 100 packs



Model FT056QN/SKU# .11822

Male RCA 90° to Female F-Connector – Nickel

- Excellent for flat panel TVs



Model FFLRM-N/SKU# .12310

RG6 and RG6Q Compression F-Connectors



Model	Color	SKU#
SOF6U-G	Gold	.10222
SOF6U-N	Nickel	.10221

BNC Compression Connectors



Model	Color	SKU#
SOBNC59U-G	Gold	.10224
SOBNC59U-N	Nickel	.10223
SOBNC23-G	Gold	.12603

CONNECTORS (CONTINUED)

Compression BNC Gold Center Pin

- Use with snap-on BNC connectors for RG6/59



Model SOBNCPIN-G/SKU# .11156

Female RCA to Female RCA Coupler

- Gold



Model RFRF-M-G/SKU# .4285

RCA RG59 Compression Connector

- Nickel



Model R59-290NR/SKU# .985

Female RCA to Male BNC

- Nickel



Model RFBMN/SKU# .2513

RCA Center Pin for RG6 – Gold

- Gold plated



Model SORCA6PINS-G/SKU# .11155

Female RCA to Female RCA Coupler

- Gold ends, black body



Model RFRF-G/SKU# .605

RCA RG6/RG6Q Compression Connector

- Nickel



Model R56-342NR/SKU# .984

Female RCA Connector

- Gold plated



Model RCAFS-G/SKU# .5883

RCA Center Pin for RG59

- Available in gold or nickel



Model	Color	SKU#
SORCA59PINS-G	Gold	.10678
SORCA59PINS-N	Nickel	.11291

Dual Female RCA Barrel

- Gold ends, black body



Model 2RF2RF-G/SKU# .4207

RCA RG6 Compression Connector

- Nickel



Model R56-324NR/SKU# .8562

Male RCA 90° to Female F-Connector

- Great for use with flat panel TVs
- Nickel



Model FFLRM-N/SKU# .12310

BNC Tool Adaptor – Nickel

- Use with CPLCCT-L compression tools for SOBNC connectors



Model SOBNC-A/SKU# .11117

Triple Female RCA Barrel

- Gold ends, black body



Model 3RF3RF-G/SKU# .1244

RCA Bulkhead Connectors

- Gold plated



Model	Insert Color	SKU#
RFNRF-G-BK	Black	.9692
RFNRF-G-BL	Blue	.9693
RFNRF-G-GN	Green	.9694
RFNRF-G-RD	Red	.4907
RFNRF-G-WH	White	.8402
RFNRF-G-YL	Yellow	.2110

Female RCA to Male F-Connector – Nickel

- Nickel



Model RFFMN/SKU# .2541

Color ID Bands for BNC Connectors

- 120 per pack, 20 of each color



Model SOIDBBNC/SKU# .10265

Male RCA to Male RCA Barrel

- Gold plated



Model RMRM-M-G/SKU# .4289

Color ID Bands for RCA Connectors

- 120 per pack, 20 of each color



Model SOIDBRCA/SKU# .10232

Male RCA to Male RCA Barrel

- 1 pair (1 red and 1 black per package)
- Gold plated ends



Model RMRM-E/SKU# .4287

Female BNC to Male RCA

- Nickel



Model BFRM/SKU# .2660

300ohm to 75ohm Push-On Adaptor



Model 30075T/SKU# .2162

CONNECTORS (CONTINUED)

Right Angle RCA Adaptor

- Male to female
- Gold plated



Model RFLRM-G/SKU# .409

Female RCA to Male 3.5mm Mono Plug

- Nickel



Model RF35M-N/SKU# .2531

Male RCA Solder-On Connector

- Solder type
- Nickel
- Two-piece



Model RM2N/SKU# .3726

Male 3.5mm Mini Stereo Phono Plug



Model 35MMS2-N/SKU# .5640

Right Angle 1 Male to 2 Female RCA Y-Adaptor

- Gold plated



Model 2RFLRM-G/SKU# .410

1 Male RCA to 2 Female RCA Y-Adaptor



Model 2RFRM/SKU# .6523

3.5mm Female to Female Bulkhead Adaptor

- Stereo



Model 35FC35F-N/SKU# .6035

2 Female BNC to 1 Male BNC T-Adaptor



Model BF2BM/SKU# .2668

Female F-Connector to Female RCA

- Nickel



Model FFRF-N/SKU# .2535

2 Female RCA to Male 3.5mm Stereo Plug



Model 2RF35M/SKU# .6526

3.5mm Female to Female Adaptor

- Black body with nickel ends
- Stereo



Model 35F35F-N/SKU# .5545

Male BNC to Male BNC

- Nickel



Model BMBM/SKU# .2665

Female F-Connector to Female RCA

- Gold plated



Model FFRF-G/SKU# .4539

Female RCA to 1/4" Mono Plug



Model RF14M-N/SKU# .908

3.5mm Mono Plug

- Mono plug with plastic sleeve



Model 35MM2N/SKU# .3347

Female F-Connector to Male BNC

- Nickel



Model FFBMN/SKU# .2510

Female F-Connector to Male RCA

- Nickel



Model FFRM-N/SKU# .2520

Male RCA Premium Gold Solder-On Connector

- Solder type



Model RM2HD-G/SKU# .11347

Female F-Connector to 3.5mm Mono Plug

- Nickel



Model FF35MN/SKU# .1857

Female RCA to Male BNC

- Nickel



Model RFBMN/SKU# .2513

1 Male RCA to 2 Female RCA Y-Adaptor

- Gold plated



Model RF2LRM-G/SKU# .3745

Male RCA Solder-On Connector

- Gold plated
- Sold in pairs (red and black)
- Solder type



Model RCAM2-G/SKU# .416

Female RCA to Male 3.5mm Mono Plug



Model RF35MN/SKU# .2531

Female BNC to Male RCA

- Nickel



Model BFRM/SKU# .2660

CONNECTORS (CONTINUED)

Female BNC Right Angle to Male BNC

- Nickel



Model BFLBM/SKU# .2673

300ohm to 75ohm Push-on Adaptor



Model 30075T/SKU# .2162

EZ RJ45 Connectors



Model 100-003
Pack of 100/SKU# .13285
Pack of 500/SKU# .13284

Male HDMI™-A to Female DVI-D Adaptor



Model HDMIFDVIM/SKU# .11112

Female BNC to Male F-Connector

- Nickel



Model BFFM/SKU# .2654

Optical Splitter

- Two-way optical splitter
- Splits one optical output into two optical outputs



Model FOF2FOF/SKU# .2948

EZ RJ45 Category 6 Connectors

- Strain relief included
- 30 per pack



Model 100-011C/SKU# .12611

Female to Female Gender Changer

- 15HD; 15 PIN VGA



Model HD15FHD15F/SKU# .5622

Female BNC to Female BNC

- Nickel



Model BFBF/SKU# .2507

Phoenix 4-Conductor Female Jack

- Two-way optical splitter
- Splits one optical output into two optical outputs



Model PHOENIX4F/SKU# .14061

EZ RJ11/12 Connectors

- 100 per pack



Model 100-026B/SKU# .12610

Keystone HDMI™ to HDMI™ Pigtail

- Flexible pigtail designed to easily bend when minimal clearance is available
- Designed to be inserted into a keystone plate to provide a finished look
- Length = 6"
- Available in Female to Female or Male to Female



Model	Color	SKU#
HDMIKPT	White	.17259
HDMIKPTMF	White	.17905

Fiber Optic Right Angle Male to Female



Model F090/SKU# .6106

3.5mm Panel Mount Stereo Jack

- Nickel



Model 35FCJS-N/SKU# .5050

Female HDMI™ to Female HDMI™ Coupler



Model HDMIFF/SKU# .11253

Toslink Extension Adaptor

- Female to Female



Model FOFFOF/SKU# .2446

2.1mm Power Plug to Terminal Screw Connector



Model 21PPTS/SKU# .19105

HDMI™ 90° Top Right Angle Adaptor



Model HDMIT90/SKU# .12634

Ground Breaker



Model GBIT/SKU# .6271

ELECTRICAL

Existing Construction Work Boxes

- 1 and 2 gang existing construction work boxes with backs open
- Sturdy design with wings to secure bracket to wall
- 20/PK



Model	Description	SKU#
EC1GWB	1 gang box	.10504
EC2GWB	2 gang box	.10508

Single Metal Bracket

- 1 gang
- 100 per pack



Model SMB/
SKU# .12866

Dual Metal Bracket

- 2 gang
- 100 per pack



Model DMB/SKU# .12867

3 Outlet Converter

- 15A, 125V, 1875 Watts
- 100 per pack



Model AC3WH/SKU# .1405

Economical Power Strip

- 3' AC cord
- 50 per pack



Model AC6E/SKU# .6257

Orange 50' Outdoor Power Extension Cord



Model PCOR50/SKU# .12982

Orange 50' 16AWG Power Extension Cord



Model PIY33Z50/
SKU# .13600

New Construction Work Boxes

- 1 and 2 gang new construction work boxes with backs open
- Sturdy design with wire tie down hole
- 20/PK



Model	Description	SKU#
NC1GWB	1 gang box	.5396
NC2GWB	2 gang box	.5398

Universal Power Supply

- 1.5V-12VDC 300VA



Model BE226/SKU# .8469

Universal Power Supply

- 12V DC 500MA



Model PS12VDC/SKU# .6406

Wall Wart Remover w/ Ground

- 6" AC
- Sold as each



Model ACWWR6/SKU# .10368

Grounding Adaptor

- Permits "U" ground 3 prong plugs to be plugged into older style 2 prong outlets
- UL listed, 15A, 125V
- 50 per pack



Model AC32/SKU# .3039

Extension Cord

- 3 outlet cords
- 50 per pack



Model	Length	Color	SKU#
ACBR6	6'	Brown	.4882
ACWH6	6'	White	.4886
ACBR9	9'	Brown	.4888
ACWH9	9'	White	.4890
ACBR12	12'	Brown	.4891
ACWH12	12'	White	.4894

Orange 50' Outdoor Power Extension Cord with 3-Way Outlet



Model PCOR503W/SKU# .13904

Orange 25' Outdoor Power Extension Cord with 3-Way Outlet



Model PCOR253W/SKU# .2705

14 Gauge Extension Cord with Right Angle Plug



Model EC1410/SKU# .19406

AC Cord

- Male right angle and female left angle



Model	Length	SKU#
ACR1RL	1'	.19879
ACR2RL	2'	.19881
ACR3RL	3'	.19377
ACR6RL	6'	.19378

AC Cord

- Male right angle and female right angle



Model	Length	SKU#
ACR1RR	1'	.19880
ACR2RR	2'	.19882
ACR3RR	3'	.19878
ACR6RR	6'	.19877

Paint Covers

- 1 and 2 gang cardboard insert protectors.
- Great for keeping the paint and drywall off your wires during new construction.
- 100/PK



Model	Description	SKU#
1GWPC	1 gang insert	.5401
2GWPC	2 gang insert	.5402

CONTACTS

Recessed Contacts

- 3/8" X 3/4" Recessed; 3/4" gap
- Surface mount quick connector with adhesive and screws
- For use in windows and doors
- 10 per pack
- All contacts use rare earth magnets that help ensure longevity



Model SB1 (White)/SKU# .18620

Roller Ball Contact

- 3/4" roller ball recessed with spacer and screws
- For use with sliding doors and windows
- 10 per pack
- All contacts use rare earth magnets that help ensure longevity



Model RB34 (White)/SKU# .18626

Recessed Contact

- Surface mount contact only
- For use in windows and doors
- All contacts use rare earth magnets that help ensure longevity



Model SB1WHCONTACT (White)/SKU# .18625

Contact Magnet

- T1 magnet only
- For use with doors, sliding doors, and windows
- All contacts use rare earth magnets that help ensure longevity



Model T1MAG (White)/SKU# .18627

Surface Mount Contact

- Surface mount contact with quick connect, adhesive, and screws
- For use in windows and doors
- 10 per pack
- All contacts use rare earth magnets that help ensure longevity



Model SURF1 (White)/SKU# .18622

Surface Mount Magnet

- 3/8" X 1-1/4" recessed with 3/4" gap
- For use with doors and windows
- All contacts use rare earth magnets that help ensure longevity

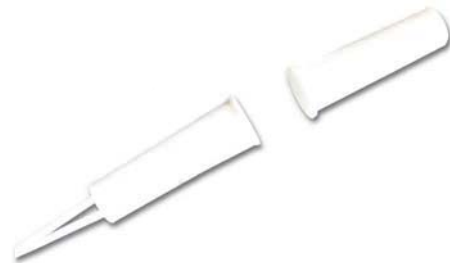

Model T1 (White)/SKU# .18621

Surface Mount Contact

- Surface mount flange
- For use in windows and doors
- All contacts use rare earth magnets that help ensure longevity



Model SURF2 (White)/SKU# .18624

Mini Magnet

- M1 mini magnet
- For use with doors and windows
- All contacts use rare earth magnets that help ensure longevity



Model M1MAG (White)/SKU# .18623

HARDWARE

Wire Nuts



Model	Quantity	Color	Gauge	SKU#
71-1K	1000	Gray	22-14	.2983
72-1K	1000	Blue	22-14	.3010
73-500	500	Orange	22-14	.3516
74-500	500	Yellow	22-10	.4135
76-1K	1000	Red	22-8	.6199
71-100	100	Gray	22-14	.9775
72-100	100	Blue	22-14	.9776
73-100	100	Orange	22-14	.9777
74-100	100	Yellow	22-10	.9778
76-100	100	Red	22-8	.9779

Bean Connectors

- "B" connectors
- Use with 19-26 gauge wire
- Sold in packs of 1000



Model	Type	Color	SKU#
B-DRY-1K	Dry	White	.1797
B-GEL-1K	Sealant	Blue	.2286

Orange Flexible Conduit

- With pull string



Model	Size	Put Up	SKU#
PC100-H250	1"	250'	.7216
PC100-H500	1"	500'	.7217
PC150-H250	1.5"	250'	.15557
PC200-H150	2"	150'	.9267

Telecom Connectors

- Sold in packs of 100



Model	Color	SKU#
UB	Blue	.4782
UG	Green	.9751
UR	Red	.4849
UY2	Yellow	.4146

Closed Connectors

- Closed end connectors
- Sold in pack quantities



Model	Type	Packs	SKU#
CE1-WH-100	22-14	100	.9773
CE1-WH-1K	22-14	1k	.9770
CE5-WH-100	12-10	100	.9774
CE5-WH-1K	12-10	1k	.9771

Model CE8-WH-1K

- Closed end 8GA window
- 1000 Pk.



SKU# .14494

Kwikpath



Model	Description	Size	SKU#
IPKPPC100	Coupler	1"	.14606
IPKPPC150	Coupler	1.5"	.15660
IPKPPC200	Coupler	2"	.14607
IPKPTA100	Terminal	1"	.14608
IPKPTA150	Terminal	1.5"	.15661
IPKPTA200	Terminal	2"	.14643
IPSEP100	End Plug	1"	.14650
IPSEP150	End Plug	1.5"	.15659
IPSEP200	End Plug	2"	.14651

Butt Connectors



Model	Size	Color	SKU#
NBS-BL-1K	14-16GA	Blue	.2259
NBS-RD-1K	18-22GA	Red	.2252
NBS-YL-1K	12-102GA	Yellow	.940

Dispenser Labels

- 3/4" width x 1-7/8" length
- Clear vinyl tape protects marking area after application
- For wire sizes from 16 gauge to 1-1/2" diameter
- U-mark area 3/4" x 1/2"
- 150 markers per dispenser



Model MKRU150/SKU# .6608

Conduit Cap

- Cap for 1" orange PVC conduit



Model PEC100/SKU# .9437

Hook and Latch



Model	Size	Color	SKU#
HL-1-WH	1" x 18 yds	White	.7373
HL-1-BK	1" x 18 yds	Black	.13494
HL-12-BK	1/2" x 18yds	Black	.13495
HL-12-WH	1/2" x 18 yds	White	.7374

Colored PVC Tape

- #60 PVC electrical tape
- Sold in 10 packs



Model	Color	SKU#
60BK	Black	.2611
60BL	Blue	.1814
60GR	Green	.3430
60GY	Grey	.1816
60RD	Red	.1818
60WH	White	.1820

Grommet

- 1-3/4" grommet for panels



Model SPR134/SKU# .9679

HARDWARE (CONTINUED)

2" Flathead Screws

- 2" screws
- 632 x 2"
- Sold in 100 Pk.

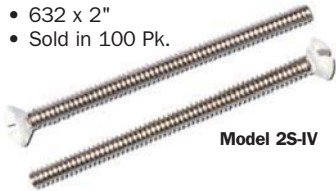

Model 2S-IV

Model	Color	Type	SKU#
2S-AL	Almond	Flat	.11962
2S-BK	Black	Flat	.11963
2S-BR	Brown	Flat	.8989
2S-IV	Ivory	Flat	.8506
2S-LA	Lt.	Flat	.15605
	Almond		
2S-WH	White	Flat	.6371
2S-PWH	White	Phillips	.8990

Cable Clamps

- Use for RG6, RG6Q, and siamese (dual) RG6
- Sold in 100 pk.



Model	Type	SKU#
CC6-WH	RG6 White	.2474
CC6-BK	RG6 Black	.2477
CC7-WH	RG6Q White	.2479
CC7-BK	RG6Q Black	.5658
CC155-BK	RG6 Dual Black	.2481
CC155-WH	RG6 Dual White	.3104

Bridle Rings

- Packs of 50



Model	Type	SKU#
BR114	1-1/4" eye diameter	.2717
BR158	1-5/8" eye diameter	.2724
BR4	4" eye diameter	.16154

Bridging Clips

- 100 Pk.



Model BC1-100/SKU# .900

1" Flathead Screws

- 1" screws
- 632 x 1" screw
- Sold in 100 Pk.



Model 1S-AL

Model	Color	Type	SKU#
1S-AL	Almond	Flat	.7481
1S-BR	Brown	Flat	.7482
1S-IV	Ivory	Flat	.7151
1S-LA	Lt.	Flat	.15812
	Almond		
1S-WH	White	Flat	.7480

Black Grip Clip for Single RG6



Model GCSBK100/SKU# .10281

Drive Rings



Model	Type	Packs	SKU#
DR58	5/8" eye diameter	100	.2721
DR114	1-1/4" eye diameter	50	.2714
DR4	4" eye diameter	50	.16155

FM Dipole Antenna

- 300 ohm



Model FM-ANT/SKU# .101

Anchor Screw Kit

- Anchor screw kit with 1/4" drill bit
- 100 per pack



Model ASK-100/SKU# .13017

Black Grip Clip for Dual RG6



Model GCDBK100/SKU# .10282

P-Hook

- P hook mounting hardware
- 100 Pk.

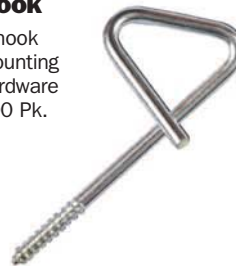

SKU# .9024

Shoe Guards

- Anti-static
- 50pr. per pack



Model SGAS/SKU# .15237

Tie Wraps



Model	Type	Color	SKU#
CT418CID-WH-100	4" 18# tie 100/PK	White	.9769
CT418M-BK-1K	4" 18# tie 1K/PK	Black	.9768
CT840C-BK-100	8" 40# tie 100/PK	Black	.7517
CT840M-BK-1K	8" 40# tie 1K/PK	Black	.7520
CT750CID-WH-100	7.5" 50# 100/PK	White	.9763
CT750CMH-BK-100	7.5" 50# Mnt. Head 100/PK	Black	.9766
CT750CMH-WH-100	7.5" 50# Mnt. Head 100/PK	White	.9764
CT750MMH-BK-1K	7.5" 50# Mnt. Head 1K/PK	Black	.9767
CT750MMH-WH-1K	7.5" 50# Mnt. Head 1K/PK	White	.9765
CT1150C-BK-100	11" 50# tie 100/PK	Black	.7518
CT1150D-BK-500	11" 50# tie 500/PK	Black	.7521
CT1450C-BK-100	14" 50# tie 100/PK	Black	.7519
CT1450D-BK-500	14" 50# tie 500/PK	Black	.7522

Water Pipe Clamp



Model WPC/SKU# .4826

Swivel Mast Mount



Model SMM/SKU# .6752

Ground Rod Clamp

- 5/8" clamp
- 100 per pack



Model A5/8/SKU# .6226

AMPS AND SPLITTERS

1 GHz Splitters

- 5-1000 MHz
- DC passing
- PCB circuitry



Model	Description	SKU#
DC2	2 way	.3580
DC3	3 way	.3581
DC4	4 way	.3583
DC6	6 way	.2715
DC8	8 way	.3584

2 GHz Splitters

- 5-2000 MHz
- DC passing
- PCB circuitry



Model	Description	SKU#
DC22G	2 way	.5486
DC32G	3 way	.5488
DC42G	4 way	.5490
DC62G	6 way	.5492
DC82G	8 way	.5493

Bi-Directional Amplifier/11dB Gain

- 11dB gain
- 1 in, 2 out
- HD ready



Model BDA11-2W/SKU# .12744

Diplexers

- Used for separating and combining satellite and VHF/UHF signals
- Covering 54-806 MHz and 950-2150 MHz
- DC power pass port provided so receiver powers LNB
- 40-2400 MHz



Model	SKU#
MX200	.2890
DPLX1	.6739

Two-Way Bi-Directional Amplifier /20dB Gain

- Bandwidth: 5-40/54-1000MHz
- Gain: 5-40MHz - .8dB, 54-1000MHz +20dB
- Hi RFI shielding 125dB
- Virtually constant level of gain
- Digital ready
- Power supply included



Model BDA20/SKU# .5052

Bi-Directional Amplifier/7.5dB Gain

- 7.5dB gain
- 1 in, 4 out
- HD ready



Model BDA75-4W/SKU# .12745

2GHz Line Amplifier

- 13 dB



Model	SKU#
2GLA	.4419

Two-Way Bi-Directional Amplifier/15dB Gain

- Bandwidth: 5-40/54-1000MHz
- Gain: 5-40MHz - .8dB, 54-1000MHz +15dB
- Hi RFI shielding 125dB
- Virtually constant level of gain
- Digital ready
- Power supply included



Model BDA15/SKU# .2289

1GHz Splitters

- 5-1000 MHz
- DC passing



Model	Description	SKU#
DSU2	2 way	.3029
SP31G	3 way	.7459
SP41G	4 way	.7460
DSV6	6 way	.2175
DSV8	8 way	.2178

TOOLS

Die for 8X110PD Punch-Down Tool

- Die only
- For use with the 8X110PD tool and Leviton jacks



Model 110LEVD/SKU# .18188

Punch-Down Tool

- 8 x 110PD punch-down tool
- For use with CAT5 or CAT6 jacks



Model 110X8-2D/SKU# .11501

EZ RJ45 Ratchet Crimp Tool

- For use with EZRJ45 100-003 connectors (SKU# .3194)

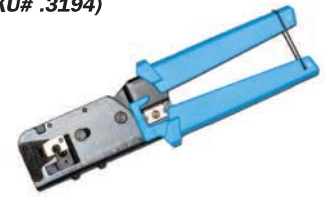

Model 100-004/SKU# .3195

Wire cutter

- Cuts up to 6 AWG wire



Model CCT8/SKU# .2652

Ratchet Crimper

- For use with RG6Q coax and BM259, BM26, BM36, BNC connectors



Model RC596Q/SKU# .2727

Crimp Tool for UR, UY, UB Connectors



Model URT/SKU# .6943

Two Blade Stripper for RG58, RG59, RG6, and RG6Q



Model ST659/SKU# .6296
Replacement Blades/SKU# .4007

Ratchet Crimper

- For use with RJ11/RJ45



Model RTC468K/SKU# .1419

High Quality Scissors

- For various electrical uses



Model ES/SKU# .6947

Self-Adjusting Wire Stripper

- Handles 10-26 gauge solid or stranded wire



Model AWST/SKU# .1488

The EZ-RJPRO™ Crimp Tool

- Crimps and trims extended wire in EZ-RJ45® connectors in a single cycle.
- Crimps and trims EZ-RJ12/11 connectors in a single cycle.
- Compatible with all other RJ-45, RJ-12/11 connectors (Except AMP.)

The EZ-RJPRO™ crimp tool is the professionals choice when working with EZ-RJ45® CAT5/5e, CAT6 and the new EZ-RJ12/11 Connector



Model 100-054C/SKU# .19570

Yellow Handle Screwdriver

- With 2 removable bits



Model 6N1/SKU# .12614

Hex Crimp Tool

- For RG59 and RG6 coax



Model HX596/SKU# .2392

CATV Security Tool for Coax



Model ST1/SKU# .5279

TOOLS

Security Bit Pack

- 62 piece set



Model SBP/SKU# .4018

Work Box Locator Tool

- Quickly measures proper location for work boxes
- Helps speed installations
- Ensures consistent box placement



Model WBL6/SKU# .11674

Linear Compliant RTC Tool

Use with .137 F56-342NR-T



Model CPLCRTC-1/SKU# .12351

Compression Tool

- For RCA, F, and BNC connectors



Model CPLCCT-SLM/SKU# .6451

Cable Continuity Toner



Model PT1CATV/SKU# .2988

Custom Compression Tool

- Use with Custom Connect connectors
- Fits RG6, RG6Q, RG59, BNC, F, and RCA SO style connectors



Model SOCCTH/SKU# .9747

F-Connector Driver

- 8" tool



Model FD8/SKU# .2718

Impact Tool

- Terminates 66/110
- Reversible clip-in blade



Model	SKU#
110 PD Tool	.3190
66 Blade	.2694
110 Blade	.2697

Custom Compression Tool

- Similar to above just a different style and compresses vertically



Model SOCCTV/SKU# .9745

About DirectConnect®

DirectConnect® was born from a request for a patch cable without a strain relief. Years ago all interconnects were molded plastic with a large molded strain relief at each end. When domestic suppliers were asked to modify the cables, their response was, “We know what the customer wants, sell what we have.” After exhausting all our suppliers, DirectConnect® began having its own products manufactured to our specifications.

The result was a cable that no longer snagged the back of cabinet shelves when equipment was pulled for service.

Cables could now be separated for individual audio and video use without the cable being damaged.

This modified interconnect was followed by an entire

product line of installer friendly products and ideas from connector and hardware bags that are re-sealable for secure storage to cable ties in 1000 packs for value pricing with inner packs of re-sealable 100s. Many products have patented designs such as the original “Nose” bulk wire plate and now the ultimate reversible “Nose” plate family. Today more than 10 patents and patent pending protected products are readily available to make your installations more profitable.

DirectConnect® has been a leader in value and quality since 1996. Each product has its own series of quality control inspections both pre-production and post-production. This process has given DirectConnect® improvements that lead to a 15 year warranty on all passive products and 2-5 years on electronic active products.

To our clients, DirectConnect® is committed to selling only to qualified installers and distributors. No retail sale has been our policy since our first sale.

Sincerely,

DirectConnect®



DirectConnect®

4747 Westpark

Houston, Texas 77027

Phone: 713.525.3225

Fax 713.525.3220

Email: sales@directconnecthome.com

1-800.531.3224 www.directconnecthome.com

